



Reduced Tillage Seeding Equipment For Small Grains

Vernon Hofman
Extension Agricultural Engineer

Carl Fanning
Extension Soils Specialist

Ed Deibert
Associate Professor of Soils

STATE UNIVERSITY
MAR 21 1989
SERIALS DEPT.
LIBRARY

Conventional small grain seeding equipment has been designed to operate most efficiently in a tilled, firm, residue-free seedbed. Unfortunately, the tillage operations required to prepare the soil for conventional seeding are expensive, leave land susceptible to erosion and enhance seedbed moisture loss through evaporation.

Recent farming technology has provided various combinations of reduced tillage systems capable of cutting costs, conserving moisture and reducing erosion. However, because these systems retain large amounts of residue on the soil surface, they require different seeding equipment.

Initial designs for no-till seeding units focused on minimum soil disturbance, but experience with numerous designs in the Northern Plains hard red wheat production area has shown that soil disturbance is not a critical factor. Initial concern was for weed problems caused by soil furrowed out on either side of the seed row. In practice, chemicals used and weed control costs have not changed as a result of seedbed disturbance.

6 Reduced tillage--or high residue--seeding equipment must meet certain requirements to be effective. Unlike conventional equipment, these requirements include a capacity to satisfactorily place seed through high levels of residue and into relatively compact soils.

Three seeding equipment designs are generally considered suitable for a reduced tillage seeding operation: hoe drills, air seeders and no-till drills (Figures 1, 2, 3).

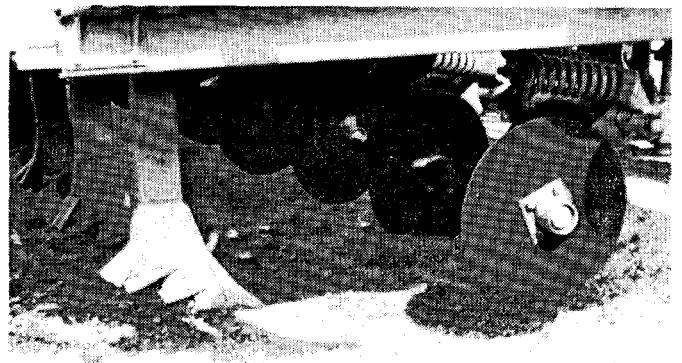

Figure 1. The hoe drill is a high clearance, rigid shank machine. Shanks are normally mounted on gangs with staggered openers for lateral clearance to ease trash flow. Field operation speed, transport features and seed metering are similar to conventional double-disc drills. Residues are moved aside for seeding.

NDSU LIBRARIES



NDSU EXTENSION SERVICE

North Dakota State University, Fargo, ND 58105

13-AENG-5-3

44.9
9
8

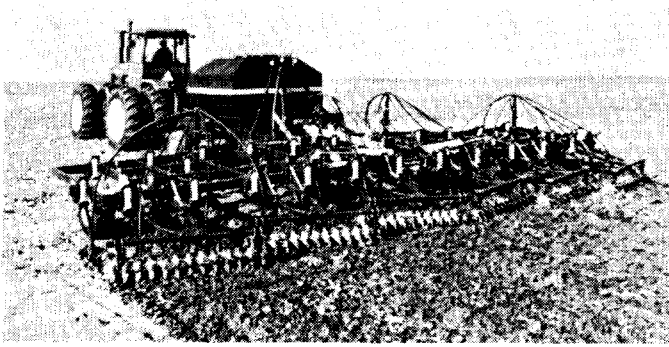

Figure 2. The air seeder concept adapts an air delivery system to conventional tillage tools. A big advantage is increased size. On large units, wings or sections can also be used. The seed tank is usually a separate unit which provides greater capacity than that found on a conventional drill. Clearance and trash handling features are similar to tillage tools. Residues are moved aside for seeding.

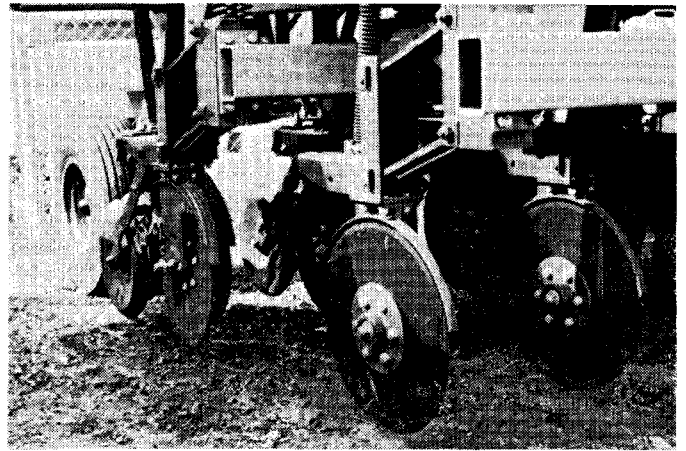

Figure 3. No-till disc drills are built heavier than conventional drills and have improved trash clearance. Field operating speeds, transport features, and seed metering systems for no-till drills are similar to conventional drills. Openers are independently mounted units designed to cut through residue for seeding.

Penetration and Residue Capacity

Conventional double-disc drills do not penetrate untilled soil or cut through heavy crop residue. No-till units have incorporated new seed openers to overcome this problem. These drills are built heavier with greater down-pressure or hydraulic controlled weight, some capable of exerting pressures in excess of 400 pounds per opener.

Openers are staggered front-to-rear to aid residue handling and have been modified to cut through residue more effectively and penetrate untilled soils. (Two disc opener designs are shown in Figures 4 and 5).

The disc opener designs pictured have been successfully used in North Dakota. Field tests have shown that wider row spacings or the use of fewer discs per seed run reduce the drill weight requirements and aid trash clearance when operating in heavy residue. Offset double-disc and single-disc seed openers are subject to wear. Essentially, the leading edge of one disc takes the abrasion and wear of all trash cutting and soil penetration. The metal-to-metal contact points on offset double-disc units and scrapers may also wear.

Leading edge double disc openers (Figure 4) have eliminated need for coulters units mounted ahead of double-disc units seeding into small grain residues. However, coulters are frequently used on units used for small grain seedings in coarse residues such as corn stalks and on shovel or other cultivator type openers operated in heavy, flattened small grain residue. Several companies offer add-on coulters units to attach ahead of seed openers.

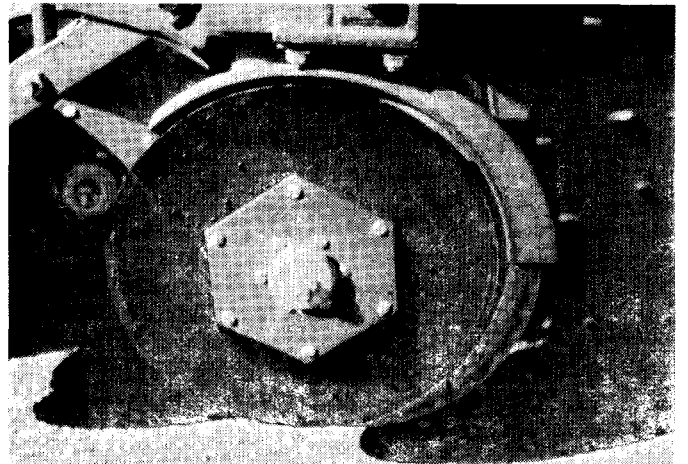

Figure 4. A double-disc opener with a leading disc to provide residue cutting similar to a single disc.

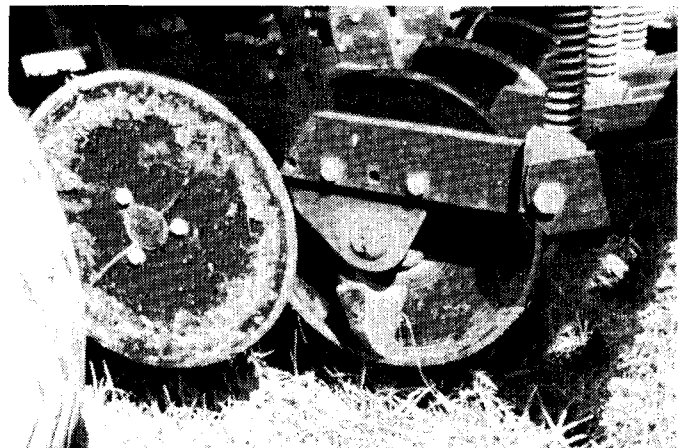

Figure 5. A single-disc opener with a seed tube shoe-scraper.

Wet conditions will reduce the straw cutting ability of a cutter or leading edge double-disc opener. Straw may "hairpin" and press into the opening made by the disc. Straw in the slot reduces seed-soil contact and can affect germination. The "hair pin" effect is minimized when seeding units operate on a firm soil with dry crisp residue.

Disc and coulters sizes vary. Tests at the University of Saskatchewan show the 18-inch diameter coulters has the best straw cutting ability of the three sizes tested (Figure 6).

While disc drills are designed to cut through residue, air seeder and hoe drill openers are designed to lift it or push it aside. Many different point or shovel shapes are available to suit different soil and trash conditions (Figure 7). Hoe-type openers disturb residue and soil more than their double-disc counterparts.

Both hoe drills and air seeders can operate well in heavy crop residues when the residue is upright and attached to the soil. However, both designs can drag straw and plug if the straw is loose, compacted or unevenly distributed.

Air seeders mounted on chisel plow frames have greater residue clearance capacity than those mounted on field cultivators or hoe drills. Residue

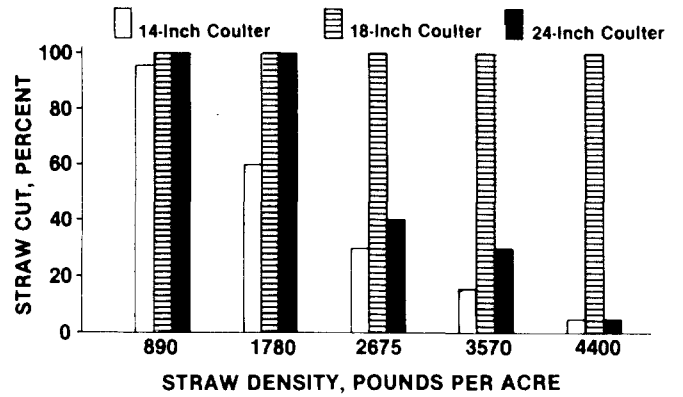

Figure 6. Effect of straw density on quantity of straw cut with the three coulters set at 2.2 inches depth of penetration.

capacity depends upon the distance between the ground and the frame, the number of ranks, the spacing between ranks and the horizontal spacing between openers. Also, mounting a cutting coulters ahead of openers will improve residue clearance.

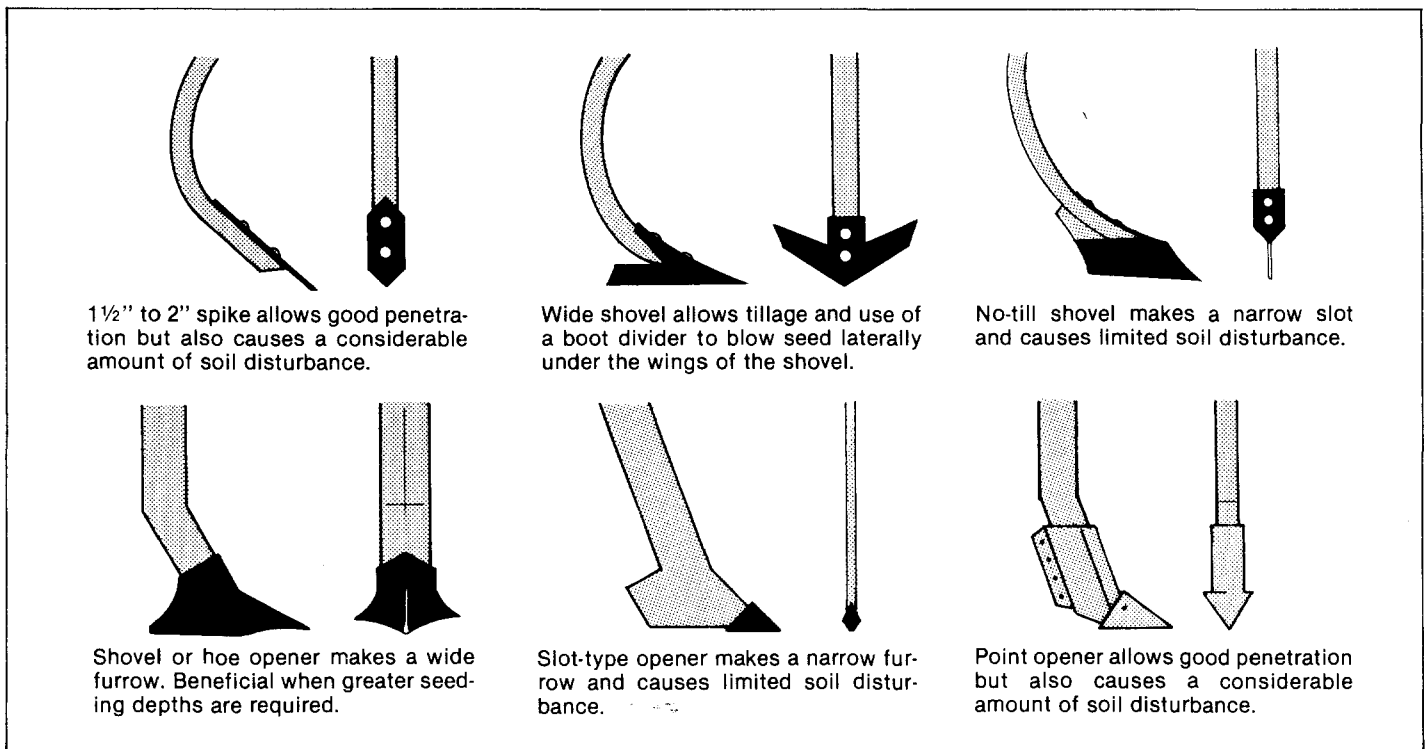

Figure 7. Shovel types for air seeders and hoe drills.

Seed Placement and Coverage

Seed depth control and seed coverage depend on the design of the seed opener. Narrow openers take less power, penetrate more easily, have good residue clearance and have less problem with adequate soil coverage over the seed.

Any seeder must have the capacity to operate at the proper depth to reach soil moisture, yet not leave excessive cover over the seed. Rapid seed germination and emergence require seeding into moist soil at a uniform depth with firming of the soil over the seed. This aids in retaining seedbed moisture.

On air seeders with sweep shovel openers, the control of seed coverage depth is improved when the seed is blown laterally under the wings of the openers. Soil tilth and moisture conditions affect the soil flow over the wings less than around the shank.

Many no-till disc drills control the depth of seed placement with a press wheel. Furrow openers and press wheels are usually mounted on the same run (Figure 8) much like row-crop planters. This design offers excellent depth control, especially when seeding into shallow loose soil. However, down-pressure springs, set to penetrate hard soil, may cause deeper seed placement when soft spots are encountered.

The maximum seeding depth for disc drills will be less than for hoe drills and air seeders. When the soil moisture needed for germination is several inches below the soil surface, air seeders and hoe drills have an advantage. Their shovels roll dry soil aside, placing seed into moisture (Figure 9).

Factors that limit seeding depth of air seeders and hoe drills are travel speed, hoe design and drill row spacing. The operating feature determining maximum seeding depth is proper seed covering. Usually, the limit is reached when the back shovels roll soil over the front furrow which covers the seed too deeply (Figure 10).

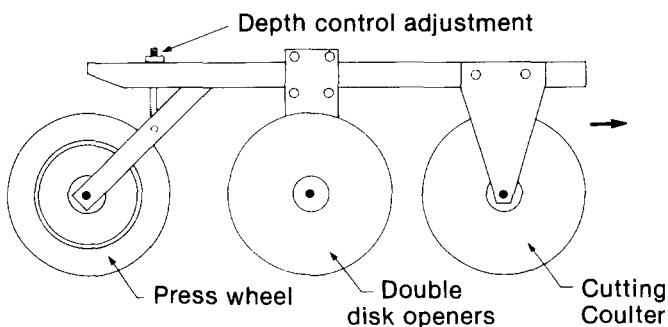

Figure 8. On most no-till disc drills the furrow opener and the press wheel are mounted on the same run to maintain depth control.

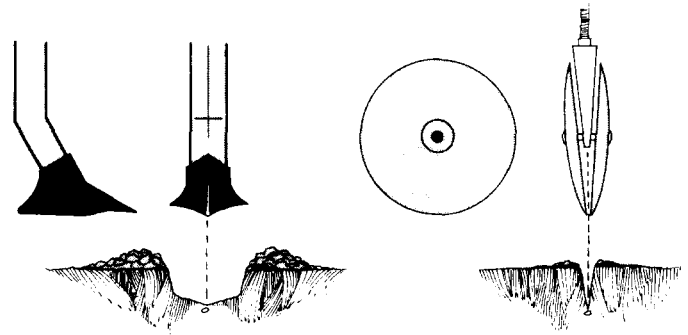

Figure 9. Shovel openers have an advantage over disc openers when moisture is several inches below the soil surface. Dry soil is rolled aside placing the seed into moisture without burying it too deep.

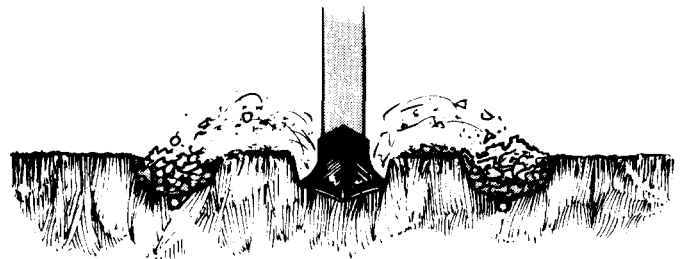

Figure 10. Maximum travel speeds with air seeders and hoe drills are usually reached when the back row of shovels roll soil over the front furrow covering the seed in the front row too deep.

In the Northern Plains, dry seedbed conditions are common for winter wheat seedings and for spring seeded grains during dry years. Hoe drills and air seeders push the dry soil away to allow seed placement in moist soil.

Shanks that collect and carry residue affect the soil flow pattern in a furrow and can have a dramatic effect on seed covering depth. Row spacings on hoe drills and air seeders are normally placed wider than conventional double-disc drills to accommodate deeper seedings without excessive seed cover.

Adverse soil texture and moisture conditions affect hoe drill and air seeder operations less than the operations of disc units. Machine operation in the field depends largely on carrier frame structure and seeding unit design. Several seeder designs are discussed in figures 11 through 15.

Maintaining a uniform seeding depth with most hoe drills and air seeders is easiest on flat ground. The fore and aft settings of air seeders mounted on cultivators and chisel plows with fold-up wings are critical for a uniform seeding depth. Multiple depth monitors and automatic adjustment by hydraulic

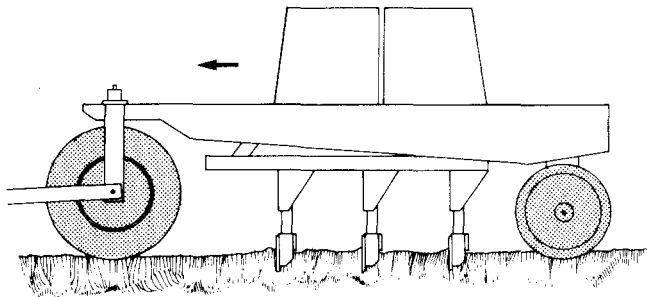

Figure 11. Most hoe drills are carried on leading wheels and press wheels. A long distance from front to rear allows wider rank spacings which improves trash clearance. However, this makes uniform seed placement difficult when operating over depressions and ridges. Shanks are mounted on rigid frame sections 7 to 14 feet wide which should follow moderate topographic variations. Some models adjust opener depth by spring pressures which can cause greater depth variations due to soil conditions.

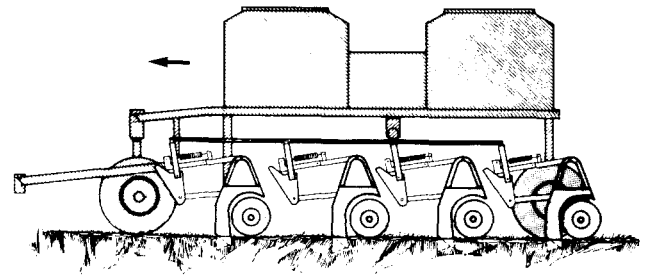

Figure 14. One hoe drill design uses four ranks of openers which allow a wider spacing for better trash clearance. Openers are mounted independent of each other with individual packer wheels and individual hydraulic lift cylinders. This feature should provide better depth control than rigid frame mounts.

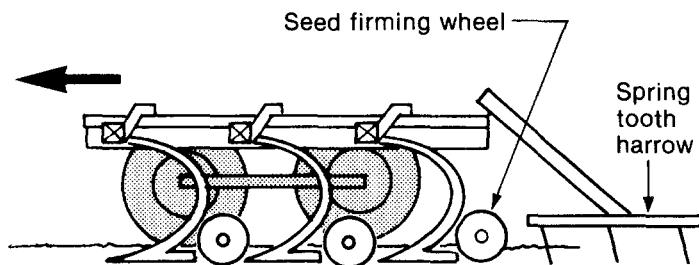

Figure 12. Many air seeders are designed with implement carrier wheels spaced 8 to 16 feet apart mounted in the center of the frame. This may improve depth control from front to rear when operating over depressions and ridges. However, variations in the depth of seed placement can occur from side to side in wide frame sections when operating over irregular terrain. Seed firming wheels mounted directly behind openers are helpful in pressing seed into moist soil.

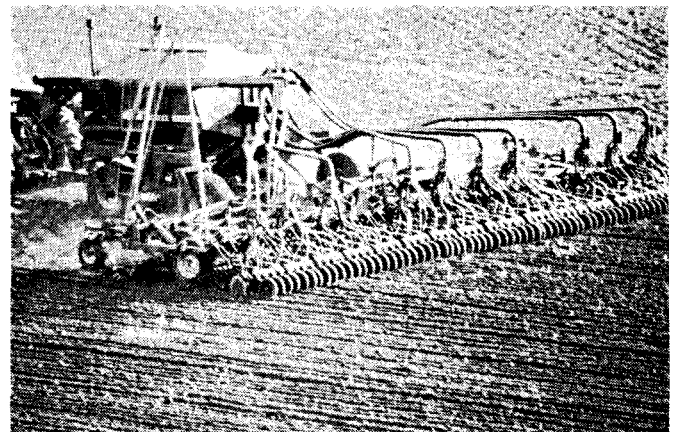

Figure 15. Some manufacturers have mounted a row of disc openers directly behind the last row of shovels on a cultivator. Seed is delivered to openers with a pneumatic conveyor. Using this unit is much like hitching a press drill directly behind a cultivator for one pass tillage and seeding. The new unit is much more compact and easy to turn at the end of the field.

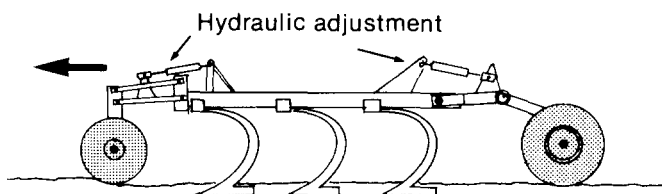

Figure 13. Some air seeders are being designed with carriage wheels in front and load carrying packer wheels in back. Depth control should be similar to that of hoe drills. This design should also provide trash clearance that is superior to that of conventional tillage tools. Load carrying packer wheels can be designed for more down pressure than spring loaded seed firming wheels.

depth control cylinders is recommended to assure seeding depth uniformity.

Drill design and performance depends on topography. Terrain with sharp elevation changes or prominent erosion features can affect drill purchase decisions.

Seeding with large hoe drills or air seeders perpendicular to a field's erosion features or directly across ridges or depressions alternately causes the machine to seed too deep or too shallow. Individually mounted units with press wheels mounted on each opener that can follow the landscape are superior on severely eroded land.

Tests conducted at the Prairie Agricultural Machinery Institute, Saskatchewan, indicated that a higher variation in seed depth placement can be expected from an air seeder mounted on a heavy duty cultivator with rigid hitches than from a conventional hoe drill unit. Seeding equipment needs a flexible hitch that allows implements to better follow slopes. However, the test results indicated seed placement was acceptable for the normal seeding of cereal

grains in level and gently rolling fields for the three air seeders tested.

Packer Wheels

Good soil-seed contact is essential for rapid germination. This can be a problem, especially when

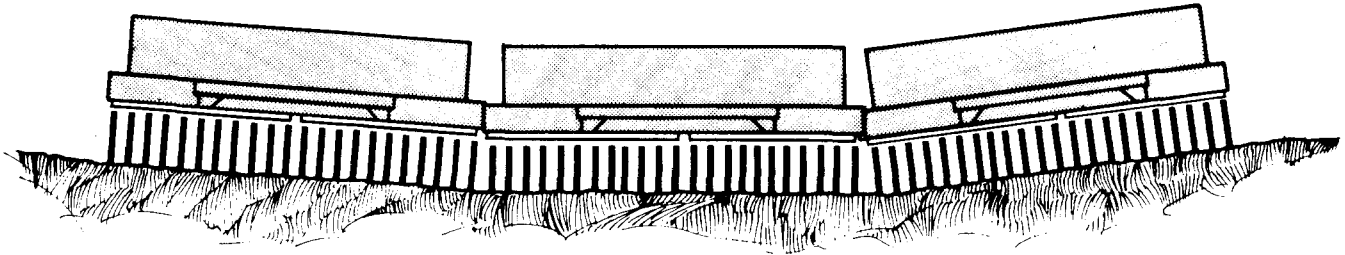

Figure 16. Wide seeders should be flexible to fit topographic variations. Ideally, seeders should flex in sections to keep seeding depths uniform.

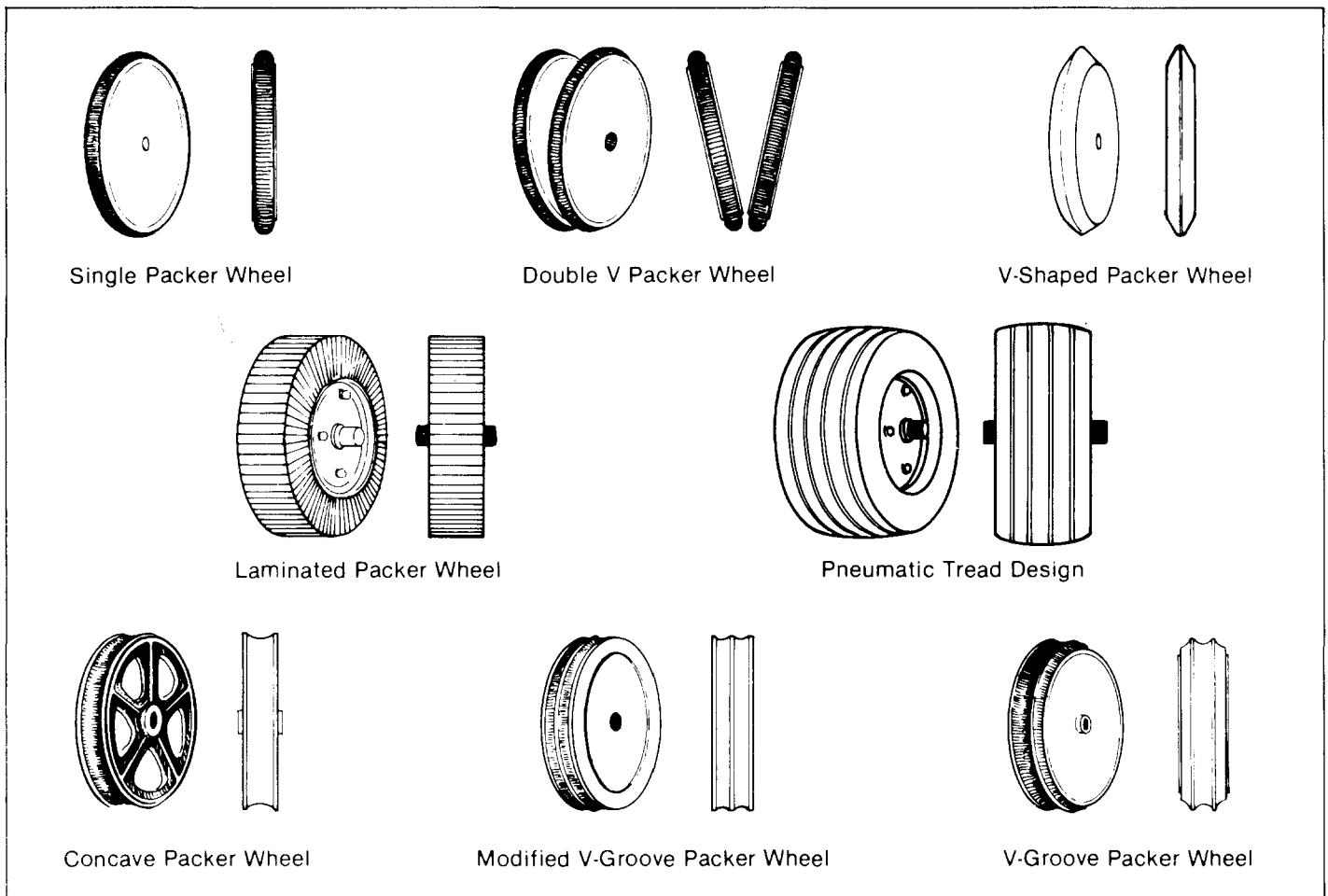

Figure 17. Many excellent packer wheels are available.

seeding in dry conditions or under reduced tillage where high-residue levels or soil clods leave voids in the seedbed.

The traditional method for achieving the desired soil-seed contact is to use packer wheels when seeding. Several excellent packer wheels for reduced-tillage seeders are available (Figure 17).

The main factors affecting seed-soil contact with packer wheel is surface area contacting the soil and the force applied. Surface area contact is dependent on packer wheel shape. Narrow or v-shaped packer wheels can be used to concentrate pressure, and may be beneficial with lightly loaded units. Wheel shape and composition also determine how clean a packer wheel runs in wet soil conditions.

A lightly loaded, flat-surface wheel will pick up and carry both mud and straw in wet soil. Steel wheels also have a greater tendency to collect wet soil than do rubber treads. Scrapers on steel wheels help overcome this problem.

Slot openings left by double-disc units present a special packer wheel problem, particularly on lightly loaded units. Double-V packer wheels (Figure 17) do a good job of closing the seed slot in heavy, wet soils under no-till conditions.

The Carrington (N.D.) Experiment Station compared an air seeder with flex-tine harrows to an air seeder with single trailing press wheels behind each opener. Both were used to seed winter cereal grains in undisturbed wheat stubble. The press wheels disturbed less stubble, and the stubble maintained better snow cover to protect the crop from winter kill (Table 1).

Table 1. A comparison of flex-tine harrows to trailing press wheels on an air seeder

Air seeder	Crop yield-Bu/Ac	
	Winter wheat	Winter rye
Flex-tine harrow	31.9	46.9
Press wheels	35.6	47.1

Seed Metering and Distribution

Seed metering accuracy for grain crops is usually not as critical as it is for row crops. Fluted feed and double run metering methods used on drills are adequate for most crops. Because of seed size differences, calibration of the metering rate prior to use is always recommended. Refer to the operators manual for the procedure to use.

The seeding rate can also be checked in the field during seeding operations. By knowing the area covered and measuring the amount of seed used, the actual seed rate can be calculated.

The Prairie Agricultural Machinery Institute tested air seeders for seed metering accuracy and uniformity. Seed uniformity distribution between runs of the tested units showed a variation of between 8 and 10 percent (Figure 18). This is acceptable at normal seeding rates.

Air seeders using pneumatic header diversions with blocked secondary header outlets had a lower uniformity rate than seeders with cup dividers placed below rubber metering rollers.

Using all secondary header outlets significantly increased uniformity. The researchers found uniformity of rollers and cup dividers similar to the uniformity obtained with most conventional drills.

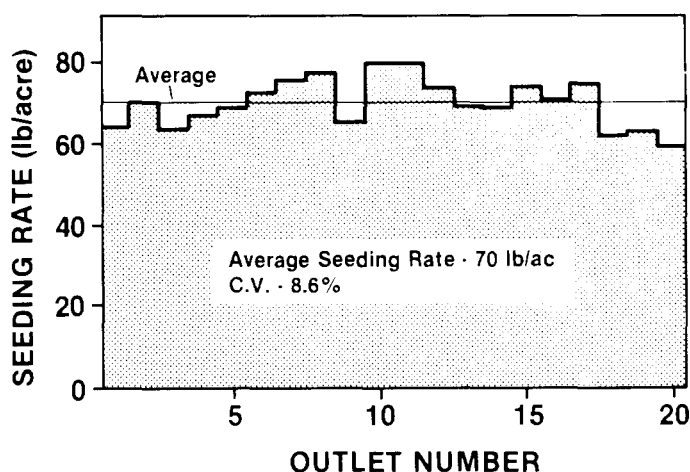

Figure 18. Typical air seeder uniformity pattern for wheat seed at 70 pounds/acre.

Fertilizer Application When Seeding

All the phosphate needed to grow a small grain crop can be applied in the seed row. However, a total fertilization program with the seeding operation is complicated by the amount of nitrogen that can be applied with the seed without causing germination damage.

Using a seeding unit where the seed and fertilizer lie in contact in a narrow band, 30 pounds of nitrogen per acre is a maximum safe limit when

(a) the nitrogen source is diammonium phosphate (18-46-0) or ammonium nitrate (34-0-0); or

(b) the seed and fertilizer are placed in a high-moisture seedbed that does not dry before seedling emergence.

When urea (46-0-0) is used, or when the seedbed has limited moisture, the nitrogen rate should be reduced to a maximum of 10 pounds per acre. Limited moisture seedbeds are common for winter wheat seedings and late spring seedings in low rainfall years.

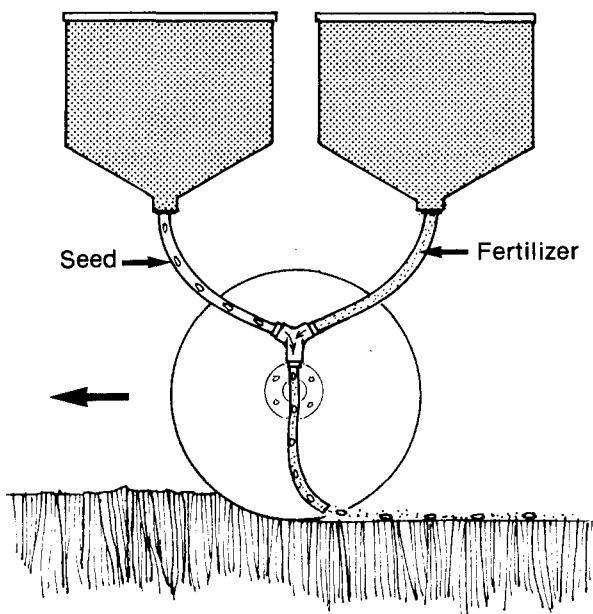

Figure 19. The amount of fertilizer that can be applied directly with the seed is limited. However, a single pass through the field accomplishing a complete seeding-fertilization program is an advantage in many management systems.

Fertilizer Application With Reduced Tillage Seeders

Several seeding equipment designs to place fertilizer separate from the seed are commercially available. This allows for a complete program of applying both nitrogen and phosphorus needs during the seeding operation. This option helps reduce trips across the field, which is a desirable management practice in most small grain production programs.

One technique involves mounting separate fertilizer openings on the seeder. Normally, a single opener applies fertilizer for two seed rows approximately 2 to 3 inches to the side and 2 inches below to provide precise seed-fertilizer row spacings (Figure 20). However, adding separate fertilizer openers

increases soil disturbances, aggravates residue clearance problems and increases power requirements.

One double-disc design features cold flow units to apply anhydrous ammonia along with dry fertilizer (Figure 21). Other designs apply either liquid fertilizer or dry granular products.

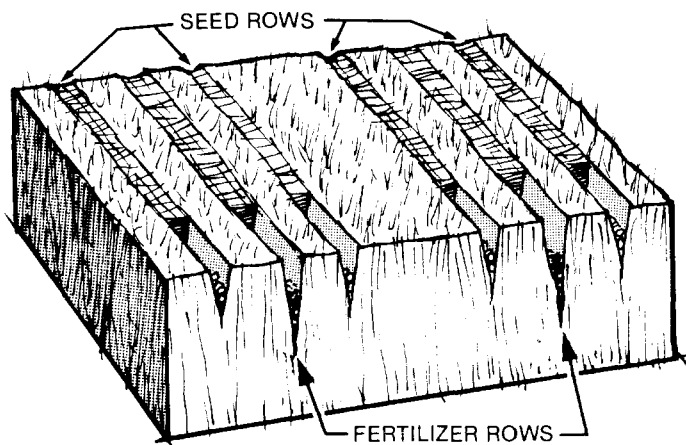

Figure 20. Several no-till seeders are designed for total fertilization during seeding. A separate row of openers is used to place nitrogen between the seed row.

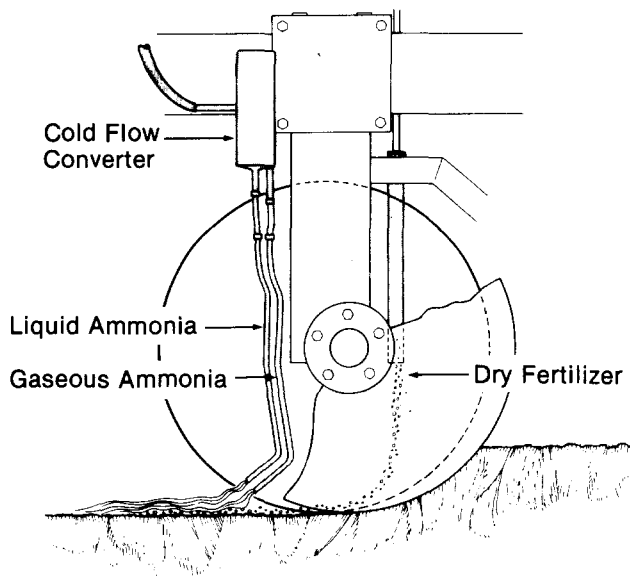

Figure 21. Cold-flow ammonia applies anhydrous ammonia to the soil as a liquid instead of a gas. It allows shallower application and closer seed placement than is practical with gaseous ammonia.

The cold flow unit is normally mounted as close to the applicator shoe as is practical because the cold liquid ammonia begins to warm as it exits the unit and vaporizes at temperatures above minus 28 degrees F. (Figure 22).

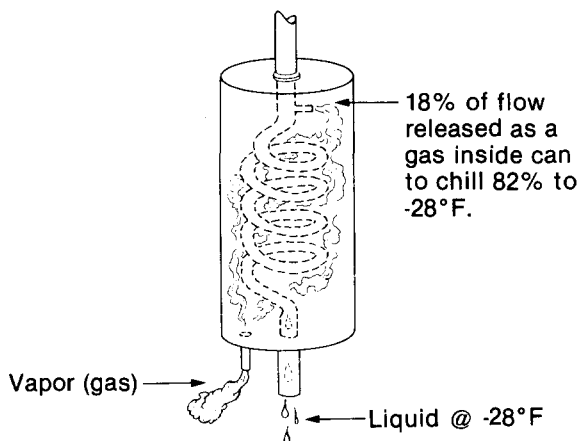

Figure 22. A combined expansion chamber and heat exchanger unit is attached between the ammonia distribution manifold and the fertilizer outlet. The cold flow unit allows a portion of the ammonia being applied to expand within a chamber and escape the chamber as a gas. The expanding gas cools the remaining ammonia passing through the unit to -28°F or less, at which it is a zero pressure liquid.

One hoe drill design combines seeding and fertilizer with a single shank. An example with this design feature is shown in Figure 23. Liquid phosphorus can be combined with liquid nitrogen and applied below the seed, or when granular phosphate fertilizers are used, applied down the drop tube with the seed.

Two examples of separate seed and fertilizer placement through an air seeder are shown in Figures 24 and 25. When ammonia is applied at seeding time, care must be used to maintain adequate space between the seed and free ammonia. This is shown in Figure 26.

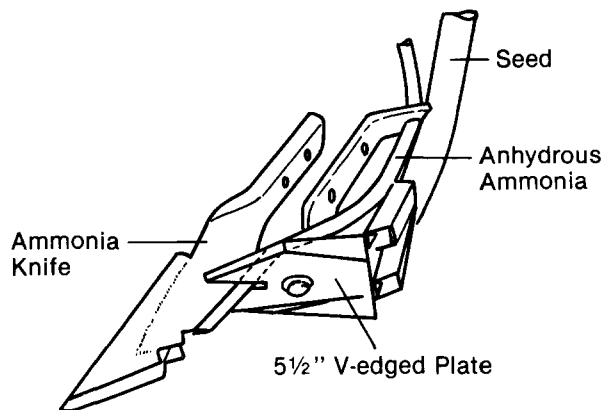

Figure 24. This ammonia knife and seeding unit is designed to be installed on a cultivator shank. It has a v-edged plate to form two grooves in the soil on each side of the fertilizer knife. This places the ammonia below and to the side of the seed.

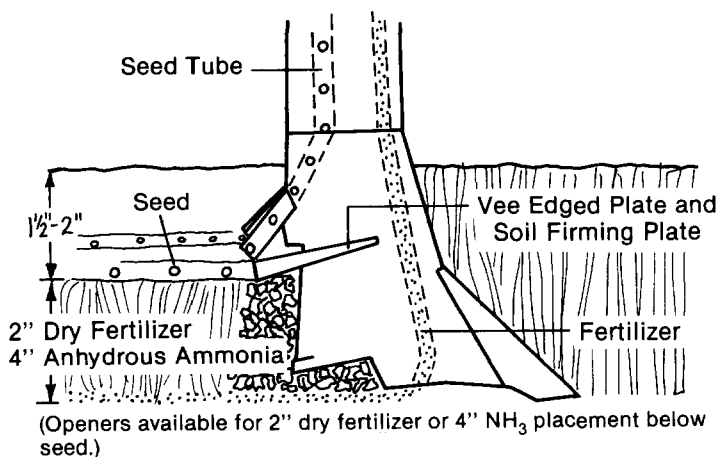

Figure 23. This combined seed-fertilizer shoe designed for a hoe drill unit performs complete fertilization and seeding in a single operation. A choice of fertilizer applicators is available for applying dry material or anhydrous ammonia. A horizontal plate compacts the soil above the fertilizer and a V-edged plate prepares a groove in the soil for the seed. This places the seed in two rows about 5 inches apart above and to the side of the fertilizer.

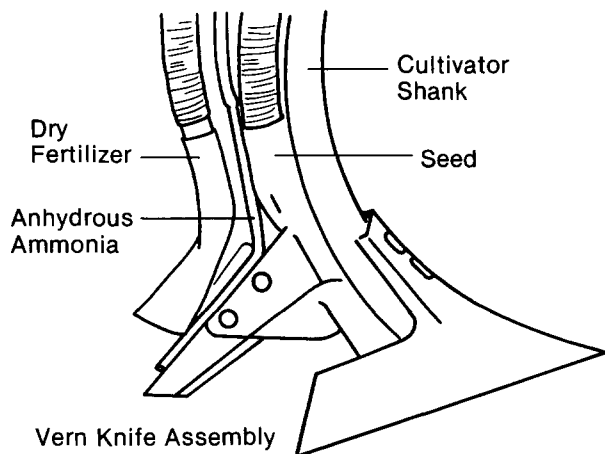

Figure 25. A cultivator sweep with a backswept knife is used to apply anhydrous ammonia and seed at the same time. Ammonia is kept separate from the seed by blowing the seed under the wings of the sweep. This unit combines a tillage operation with the seeding and fertilizer application.

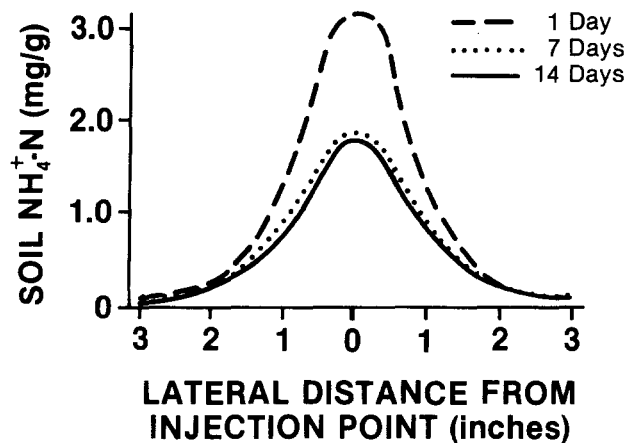

Figure 26. High ammonium concentrations are found about 2 inches laterally from the ammonia application point in the soil (3). Application rate was 180 pounds/acre nitrogen.

All seeding units perform best in a firm high moisture seedbed. A packer wheel over the seed row helps improve performance and becomes an essential component when operating in a rough, dry seedbed.

The use of an air seeder offers an opportunity to increase rates of granular nitrogen applied directly with the seed. When shovels are used with a flow divider at the base of the opener that blows material out under the shovel wings, both seed and fertilizer are spread in a wide band on either side of the shovel. This effectively reduces seed-fertilizer contact, compared to narrow band applications, and increases safety for seed germination (Figure 27).

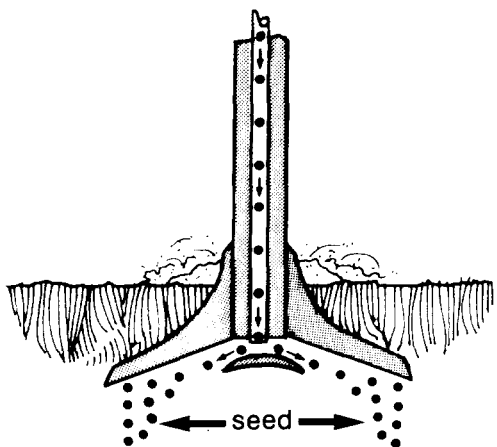

Figure 27. Using shovels with a flow divider on an air seeder distributes the seed over a wider area.

Recent North Dakota studies of seed and fertilizer placement with an air seeder have shown that substantial amounts of fertilizer can be spread with the seed when both are spread across the width of cultivator sweeps. Placing seed and fertilizer together (40 to 80 pounds or more per acre) in a narrow strip will reduce plant growth (Table 2). Placing fertilizer in a band below the seeding depth gives response nearly equal to the wide spread of seed and fertilizer behind a cultivator sweep.

The nitrogen limit that can be placed with the seed may be increased safely with wide-band air seeder application. The maximum rate that can be safely applied will depend upon the seed-fertilizer band width and the seedbed moisture available through the crop's germination and emergence stages. Research data and grower experience indicate nitrogen rates of 80 pounds per acre on cereal grains are possible in a high moisture seedbed, with adequate spread.

An alternative to applying fertilizers during the seeding operation is to apply them in a separate operation. Many no-till or reduced till drill manufacturers are offering seeding units with the paired row concept. This design improves trash clearance and reduces opener numbers by applying fertilizer between two narrow spaced openers with wide spacing to the next pair of rows. These drills supply two seed rows with nutrients from one fertilizer row. Fertilizer is usually placed about two inches to the side and two inches below the seed rows (Figure 20).

While both nitrogen and phosphorus can be applied in the fall or prior to spring seeding, fall applications have several advantages. They reduce the spring workload and avoid seed germination problems resulting from rough seedbeds and irregular drying. Also, a better price may be available in the fall.

Air seeders function well as either seeders or fertilizer applicators. The soil disturbance caused by an application in the fall weathers over winter and has little effect on seedbed moisture or weed growth in spring grain no-till seedings.

Power Requirements

The draft requirements of most no-till seeders are higher than those of their conventional counterpart. However, because of the field conditions affecting a tractor's rolling resistance, the power requirements of the two types of equipment may be similar.

When operating on untilled soil, a tractor encounters less rolling resistance than on tilled soil. This means it is able to develop higher traction efficiency, and consequently the fuel requirement for a

Table 2. Yield of Spring Wheat with One Pass Air Seeder as Influenced by Spreader Type and Fertilizer Rate, at Casselton, North Dakota, 1986 and 1987* (3, 4).

FERT. RATE		1986				1987			
N	P	Single Row	5" Spread	8"-10" Spread	12" Spread	Single Row	5" Spread	8"-10" Spread	12" Spread
-lb/ac-		----- bu/acre -----							
0	0	26.1	27.2	28.0	31.2	33.2	35.7	38.9	37.9
40	0	28.5	35.5	42.6	41.8				
80	0	24.3	35.8	43.1	42.5	25.0	42.8	51.1	54.2
40	17	30.3	36.2	43.0	42.1	30.4	41.0	50.3	51.7
80	17	21.2	36.0	44.5	43.1	20.4	39.2	43.9	52.2

* Trials were completed using a 24-foot air seeder chisel plow with a 12-inch opener spacing. The seed and fertilizer placement were:

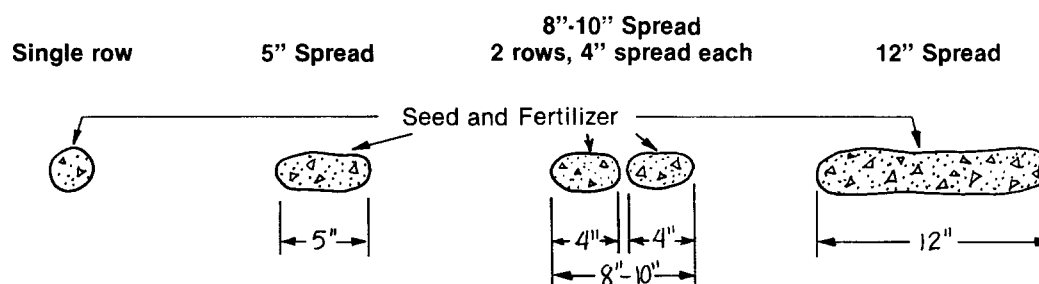

given load pulled on tilled soil may be similar to a slightly heavier load on untilled soil.

An NDSU fuel records program revealed that farmers use an average of .5 gallons of fuel per acre when pulling conventional seeders on tilled ground, but use .56 gallons per acre when pulling typical no-till seeders on untilled ground.

The weight of large, fully loaded no-till seeders can exceed 2,500 pounds per foot of drill width when full of seed and fertilizer. Their power and fuel requirements are considerably higher than those of smaller or lighter units.

Typical no-till seeders have a power requirement of 5 to 7 PTO horsepower per foot of drill width, while the larger, heavier units require around 15 PTO horsepower per foot of drill width.

Summary

Most no-till disc drills should have little trouble operating in heavy residue except when the soil or

straw is wet or when the straw is not evenly spread. Generally, the depth of each opener is independently controlled by a packer wheel. This design should provide superior seeding depth uniformity over irregular surface features. However, the maximum seeding depth of disc drills is limited. Also, when operating in heavy residue, straw may be pushed into the seed slot, reducing soil-seed contact and slowing or reducing germination.

Hoe drills have an advantage when seeding in dry conditions. The hoe openers push dry soil aside, assuring seed contact with moist soil. However, the residue clearance capacity of most hoe drills is limited, especially if the straw is not anchored to the soil. Units with wheels in front and press wheels in back should provide uniform seeding depths over moderate topographic variations.

Air seeders have distinct advantages when operating at high speeds or when coverage of large acreages is required. Units mounted on tillage equipment frames have a greater residue handling capacity than hoe drills. The limitation of air seeders mounted on tillage tool frames has been the lack of uniform seeding depth when operating over uneven terrain. New designs, with flexible frame sections, flexible draw bar units and packer wheels that are

structural weight-carrying components, provide seeding depth uniformity similar to that provided by hoe drills.

References

1. Allam, R. K., E. H. Wiens, "Air Seeder Testing", Prairie Agricultural Machinery Institute, Paper No. 81-323, American Society of Agricultural Engineers, August 1981, St. Joseph, Michigan.
2. Jacobsen, J. S., R. L. Westerman and P. L. Clyzsoal, 1986. "Distribution of Applied Anhydrous in Soils and Germination Hazards to Winter Wheat". Soil Science Society of America. Vo. 50, pp 1606-1612.
3. Deibert, E. J. 1986. "One-pass Pneumatic Fertilizing- Seeding with Various N Sources and N Rates," p. 120-125. In Great Plains Soil Fertility Workshop Proceedings. Denver, Colorado. 4-5 March 1986.
4. Deibert, E. J., D. A. Lizotte, and B. R. Bock. 1985. "Wheat Seed Germination as Influenced by Fertilizer Rate, Fertilizer Source and Spreader Type with One-pass Pneumatic Seeding-Fertilizing." North Dakota Farm Res. 42(6):14-20.

Helping You Put Knowledge To Work

NDSU Extension Service. North Dakota State University of Agriculture and Applied Science, and U.S. Department of Agriculture cooperating. William H. Pietsch, Director, Fargo, North Dakota. Distributed in furtherance of the Acts of Congress of May 8 and June 30, 1914. We offer our programs and facilities to all persons regardless of race, color, sex, religion, age, national origin, or handicap; and are an equal opportunity employer.