

Wetlands Research Center

Rachel McGinn
Fall 2015
Mark Barnhouse

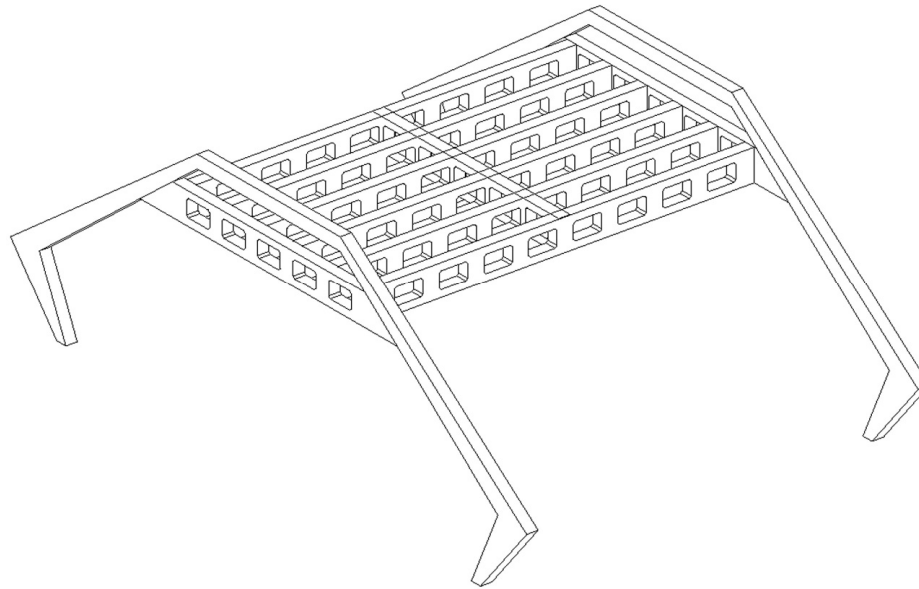

Process

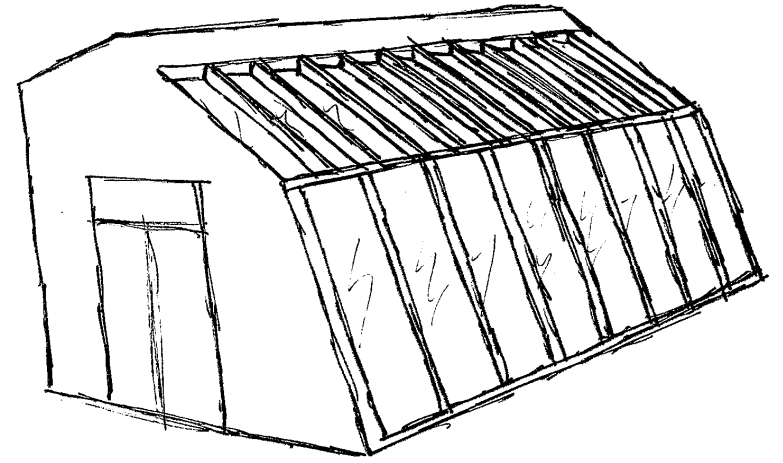
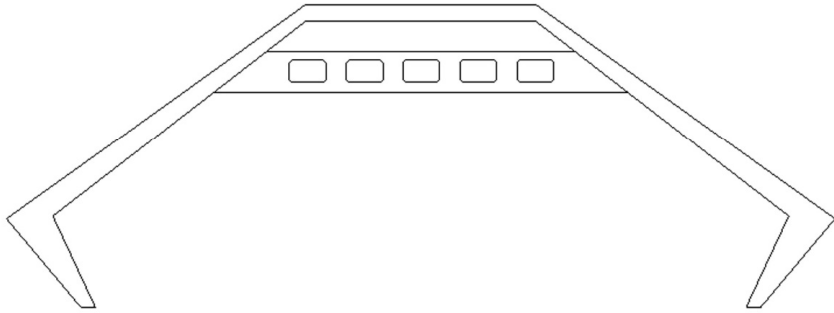

The Site

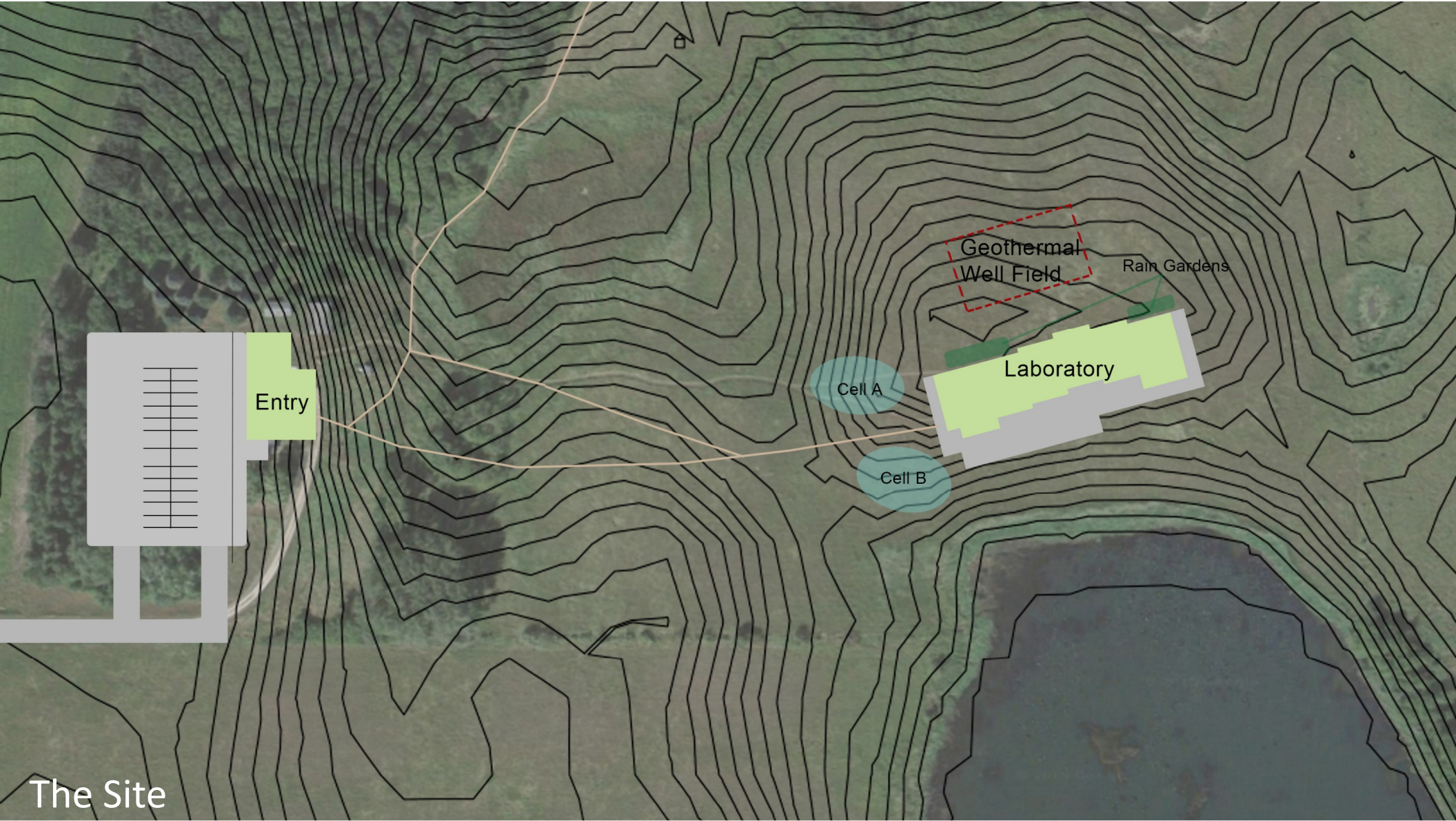

Entry

Cell A

Cell B

Laboratory

Geothermal Well Field

Rain Gardens

The Site

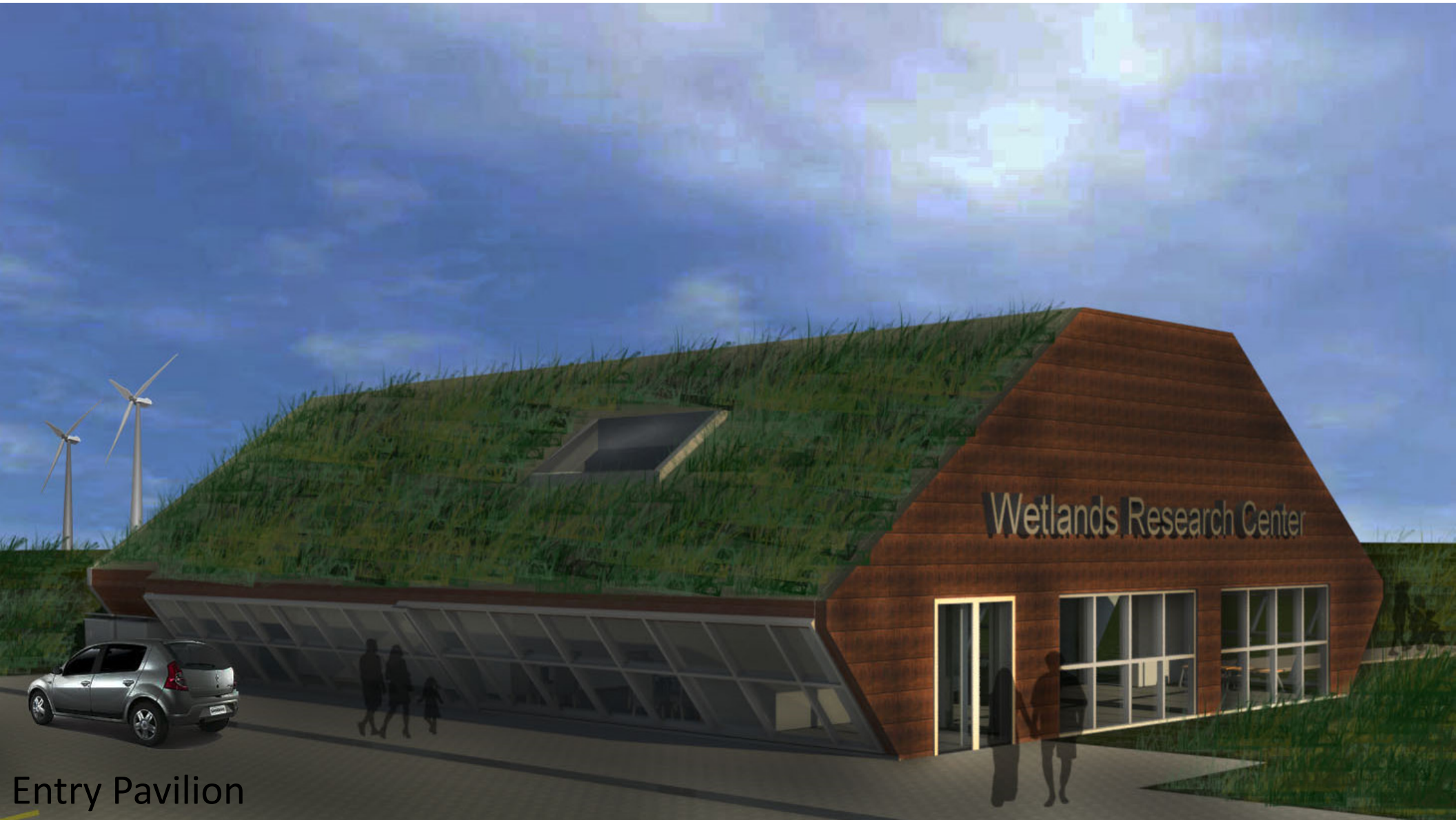

Entry Pavilion

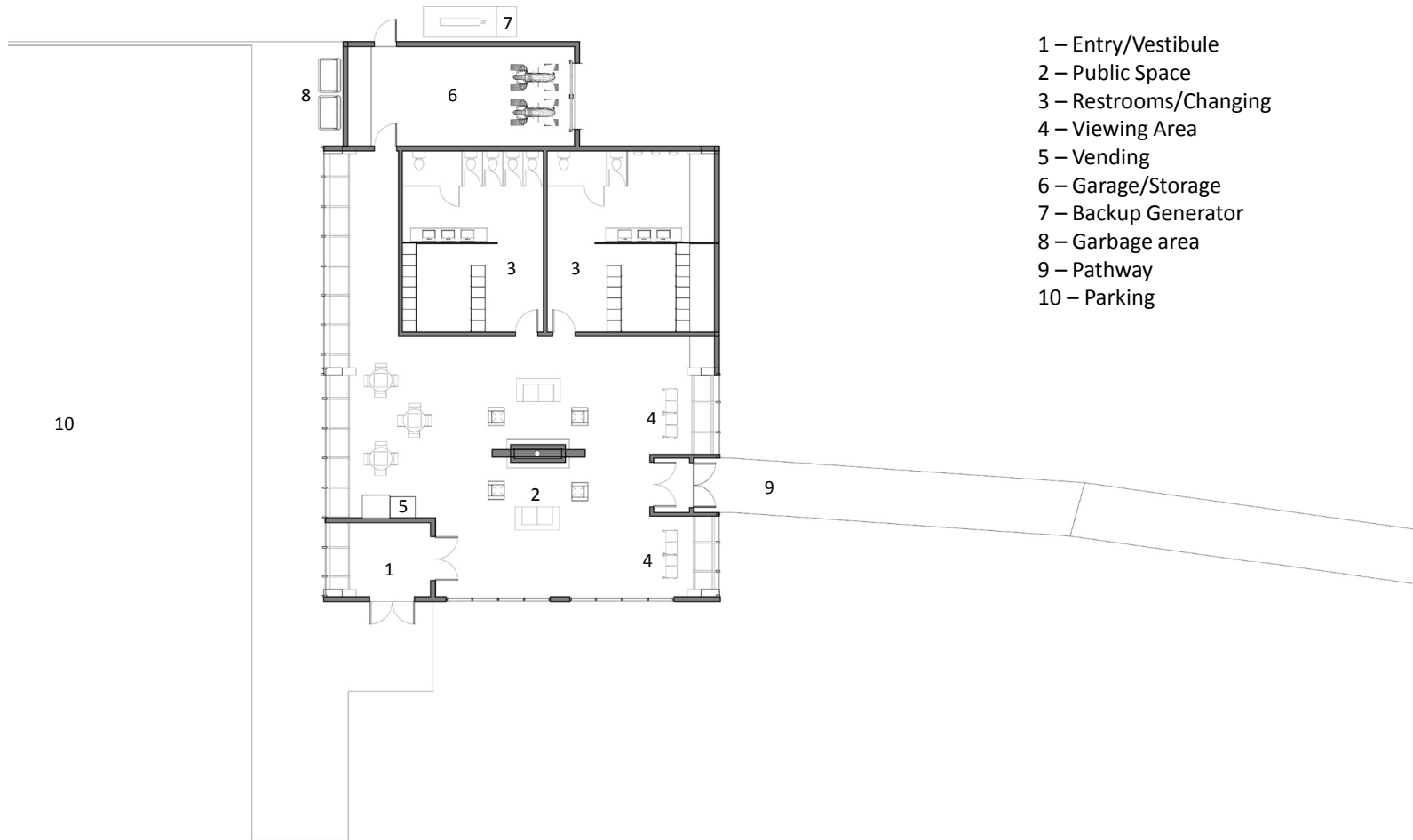

- 1 – Entry/Vestibule
- 2 – Public Space
- 3 – Restrooms/Changing
- 4 – Viewing Area
- 5 – Vending
- 6 – Garage/Storage
- 7 – Backup Generator
- 8 – Garbage area
- 9 – Pathway
- 10 – Parking

Entry Pavilion Floor Plan



Interior Entry Pavilion



- 1 – Entry
- 2 – Public Space
- 3 – Viewing Areas
- 4 – Reception
- 5 – Office
- 6 – Mechanical
- 7 – Conference Room
- 8 – Presentation Room
- 9 – Lounge
- 10 – Computer Server Room
- 11 – Lab
- 12 – Greenhouse
- 13 – Restrooms
- 14 – Mail/Workroom

Laboratory Floor Plan

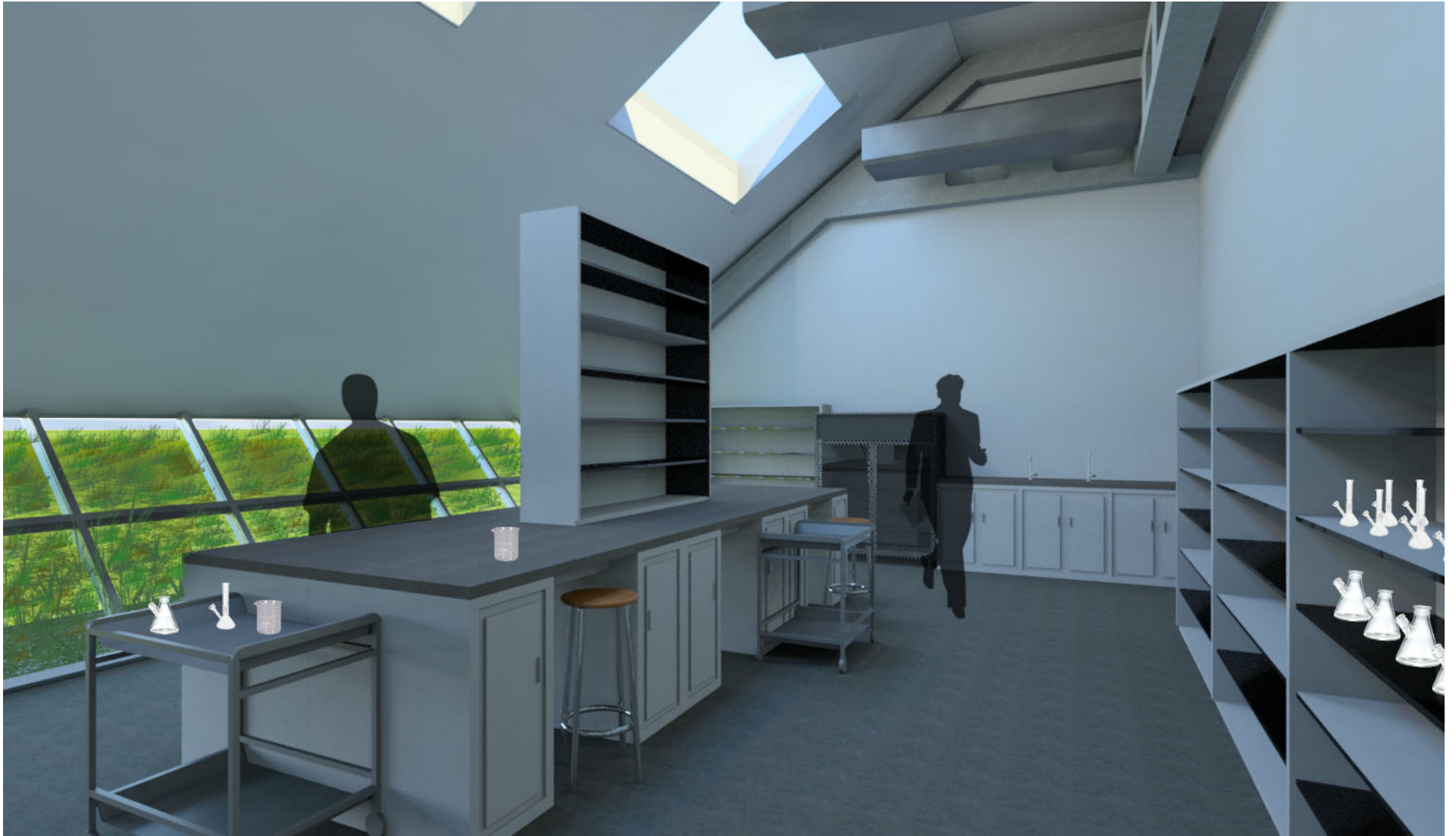

Laboratory Space

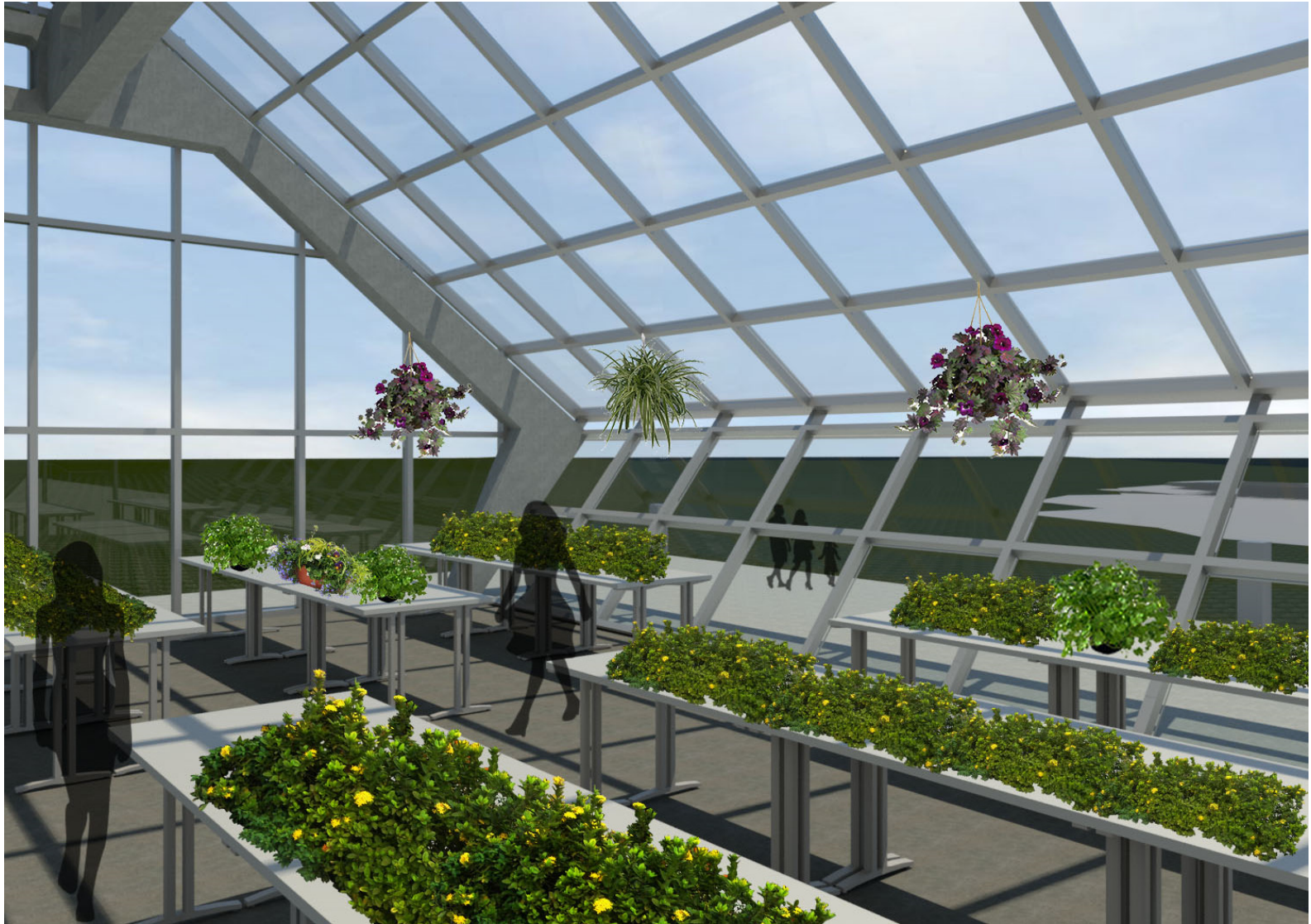

Greenhouse Space

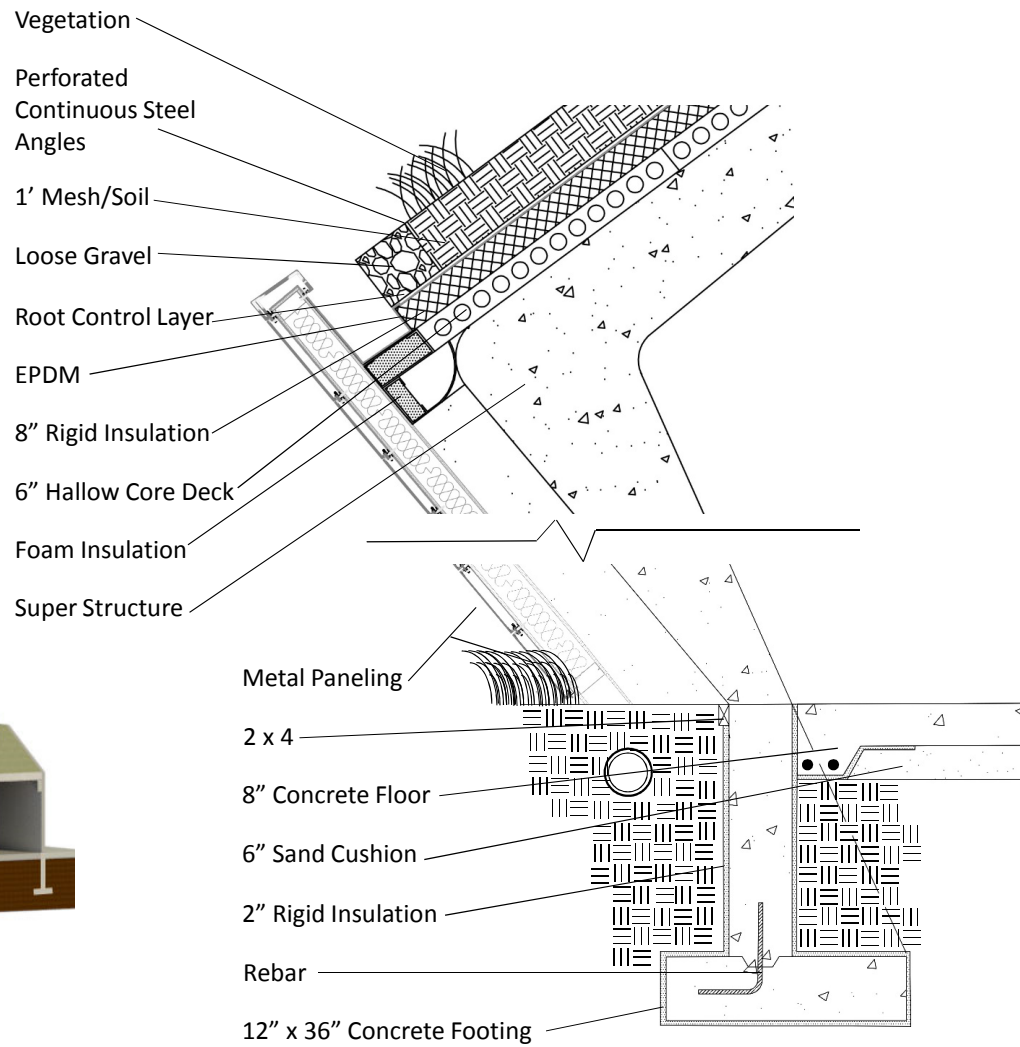
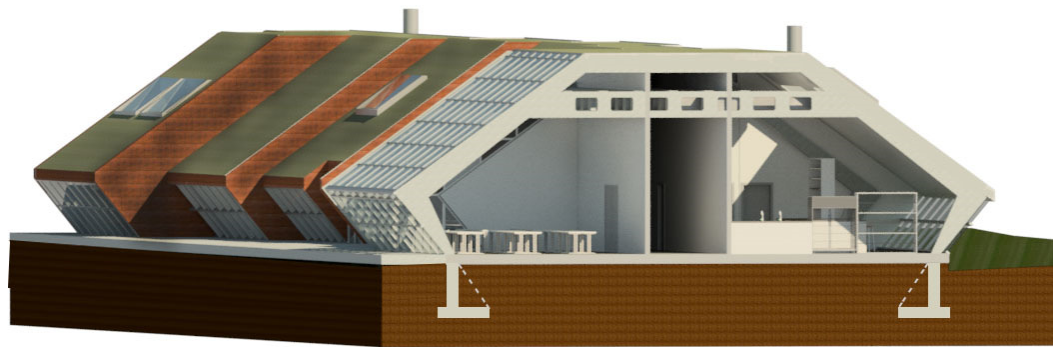

Section