

ENUMERATION OF REDUCED WORDS OF LENGTH N FOR COXETER GROUPS VIA
BRINK-HOWLETT AUTOMATON

A Paper
Submitted to the Graduate Faculty
of the
North Dakota State University
of Agriculture and Applied Science

By
Brandon James Allen

In Partial Fulfillment of the Requirements
for the Degree of
MASTER OF SCIENCE

Major Department:
Mathematics

December 2022

Fargo, North Dakota

NORTH DAKOTA STATE UNIVERSITY

Graduate School

Title

ENUMERATION OF REDUCED WORDS OF LENGTH N FOR COXETER
GROUPS VIA BRINK-HOWLETT AUTOMATON

By

Brandon James Allen

The supervisory committee certifies that this paper complies with North Dakota State University's regulations and meets the accepted standards for the degree of

MASTER OF SCIENCE

SUPERVISORY COMMITTEE:

Dr. Azer Akhmedov

Chair

Dr. Jessica Striker

Dr. Torin Greenwood

Dr. Simone Ludwig

Approved:

10/3/2022

Date

Dr. Friedrich Littmann

Department Chair

ABSTRACT

The overall goal of this paper is to give a method of computing out how many words of length n there are for any Coxeter group via its Brink-Howlett automaton. [6] [7] To build our automaton, we focus on Coxeter systems and root systems honing in on a special set of roots called the small roots. We follow closely [1] [5] for the first two chapters. Finally, we build the Brink-Howlett automaton through literature compiled through the years and present explicit examples of \tilde{A}_1 and the Coxeter group on three generators which each pair of generators is in a free relation with one another.[14] [19] [24]

ACKNOWLEDGEMENTS

Firstly, I would like to thank those whom have looked over my work for the past few years while working on this problem. I would specifically like to thank Dr. Azer Akhmedov for working to finalize this paper and Dr. Jessica Striker for their initial reviews upon my paper.

Secondly, I would like to thank Dr. Federico Ardila for his course lectures on-line in the field of Algebraic Combinatorics. For one who is interested in studying into Algebraic Combinatorics his website is very valuable.

Also, I would also like to thank New South Wales University of Sydney for cultivating the Brink-Howlett automaton for the previous few decades.

I would also like to thank North Dakota State University for giving me the time and space to cultivate this paper into fruition.

Finally, I would like to thank those who have motivated me to push forward in Mathematics.

DEDICATION

This thesis is dedicated to my family and friends in the past, present, and future.

PREFACE

I shall give a brief overview context about how I ran into the problem stated above in the abstract. It may not be the easiest path to follow, but a lot has been gained over the years of studying Algebraic Combinatorics. A lot of material from this paper comes from [1] and [5].

As one goes through a course in Algebra, one may question how many words of length n there are for a general presentation of a group. The answer comes from the intersection of two fields, Coxeter Group Theory and the Theory of Automata. It is natural for any group W to be defined by its presentation. Recall a presentation for a group W can be given as $W \cong \langle S \mid R \rangle$. We represent the group elements as words in the alphabet of our generators S and R is the relations in the group that give the identity through the operation of concatenation. Doing this leads to advantages and disadvantages. For one advantage, the multiplication of the words is given by the operation of concatenation. This is useful in the field Computer Science with implementation into data structures. There can also be disadvantages. There can be a plethora amount of words that correspond to the same group element, and in general, there is no finite algorithm that tells whether two different words are equivalent. This is known as the *word problem*. Also, there is no finite algorithm that will reduce a word to an equivalent shortest possible word. This is known as the *reduction problem*. Even worse, for that reduced word there may not exist a way for a word to be fully proved to be reduced. This is known as the *recognition problem*.

All Coxeter groups do solve the word problem. [23] Coxeter groups have seen to have a prolific effects in the areas of Geometry, Topology, Combinatorics, Algebra, Polyhedra, Computer Science, Physics, Chemistry, and Biology for the past 75 years. In fact, one may not realize that one has seen a Coxeter group until one reaches presentations of groups during their mathematical studies.

The amount of effort to prove a nice power-series representation for the words of length n for a general group has been perpetuated for over a century and still going on today with computer implementation of automata of Coxeter groups.[2] Also, in the *Journal of Algebra* has released some aspects of Coxeter groups having the minimal automaton.[19] The development is not as simple as

one may think. There many foundational aspects one needs to establish and prove to establish the result of automata of Coxeter groups.

There are many other problems in Coxeter groups in which researchers are interested in. The problems started with the influence of Dehn in 1911 and 1912 first looking at surface groups.[10] We list them below:

- *Word problem*: Given an arbitrary word w in a group G , decide in a finite number of steps whether or not w defines the group identity. (Solved, [23])
- *Conjugacy problem*: Given two words w, v of a group G , decide in a finite number of steps whether or not the words are conjugate to each other. (Solved, [16])
- *Isomorphism problem*: Given a group H with a different presentation decide in a finite number of steps whether a group G and H are isomorphic. This problem is currently ongoing with respect to Artin automorphisms.[3]

This paper focuses on developing the Brink-Howlett automaton for the first three chapters. We follow in accordance with [5] for the first two chapters. For chapter three, we consult the literature that has been developed since 1990's starting with Brink's Ph.D thesis [7] to current day information on the Brink-Howlett automaton.

One of the most viable tools to study the problem of enumerating reduced words of length n comes from the Brink-Howlett automaton. This automaton puts a Coxeter group into a finite state automaton.[6] [7] This automaton counts reduced words of length n for a general Coxeter group and each reduced word corresponds to walk in its geometry via the group's hyperplane arrangement.

TABLE OF CONTENTS

ABSTRACT	iii
ACKNOWLEDGEMENTS	iv
DEDICATION	v
PREFACE	vi
LIST OF TABLES	ix
LIST OF FIGURES	x
1. COXETER GROUPS	1
1.1. Basics of Coxeter Groups	1
2. POSETS AND ROOT SYSTEMS	12
2.1. Posets	12
2.2. Root Systems	15
2.2.1. Small Roots	24
3. AUTOMATA OF COXETER GROUPS	30
3.1. Automata	30
3.1.1. Brink-Howlett Automaton and Examples	36
3.2. Conclusion	41
REFERENCES	42

LIST OF TABLES

<u>Table</u>	<u>Page</u>
2.1. Non-Exceptional Root Systems	16
2.2. Permuting Type A_2 Roots	18
3.1. Number of States for Affine Irreducible Coxeter Groups	40

LIST OF FIGURES

<u>Figure</u>	<u>Page</u>
1.1. Hyperplane Arrangement of S_3	1
1.2. Finite Irreducible Coxeter Groups [22]	3
1.3. Affine Irreducible Coxeter Groups [22]	3
1.4. Coxeter Diagram	4
1.5. String Diagram	7
2.1. Weak Right Bruhat Order of S_3	13
2.2. Strong Bruhat Order of S_3	13
2.3. Root System Examples	16
2.4. Type A_2 Root System	17
2.5. Type B_2 Root System	17
2.6. Root Poset of A_3	23
2.7. Dynkin Diagram of \tilde{A}_{n-1}	24
2.8. Root Poset of \tilde{A}_2	24
3.1. \tilde{A}_1 Automaton	31
3.2. \tilde{A}_1 Brink-Howlett Automaton	37
3.3. $U(\tilde{A}_2)$ Brink-Howlett Automaton	38

1. COXETER GROUPS

1.1. Basics of Coxeter Groups

One starts in a basic Abstract Algebra course with permutation group S_n . One can label a set of balls 1 through n where each ball is distinguishable. One then can reorder the balls to represent an element of S_n . We use one-line permutation notation here. What is not so obvious is that we can give a geometric interpretation of S_n via a hyperplane arrangement. We start with a visual representation of S_3 via hyperplane arrangements, where each hyperplane labeled swaps the coordinates with respect to the labeling of the hyperplane. For example, starting with the identity element at the bottom, 123, we reflect over the plane labeled $X_1 = X_2$ that swaps position 1 and 2 of our element to get a new element of S_3 , 213.

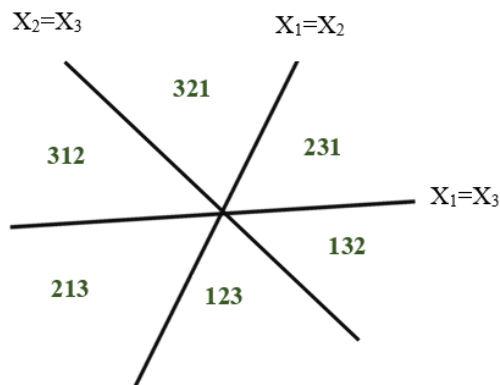

Figure 1.1. Hyperplane Arrangement of S_3

One can see through the way of transpositions $s_i = (i, i+1)$ for S_3 we will get the polynomial of reduced words of length n being $R_{(S_3, \{s_1, s_2\})}(q) = 1 + 2q + 2q^2 + q^3$ where the coefficient of each degree n represents the number of reduced words of length n for the group. The definition of length will be given a little later on and we will encounter a proof of the following polynomial in the second chapter using the weak right Bruhat order in chapter 2. In our example, we have one word of length zero, the identity element 123, two words of length one, 213, 132, two words of length two, 312, 231 and one word of length three, 321. Hyperplane arrangements will be of importance to us in the next

chapter with consideration of root systems, since Coxeter groups have a nice symmetric geometric structure.

We begin this paper with the definition of a Coxeter system. We then go forward with some groundwork theorems, propositions and definitions we will need in the future. We follow [5] for this chapter.

Definition 1.1.1. A **Coxeter system** is a pair (W, S) where W is a group (*Coxeter group*), with presentation $\langle S \mid R \rangle$, for $S = \{s_i\}_{i \in I}$, a function $m_{i,j} : S \times S \rightarrow \{\mathbb{N} \setminus 0\} \cup \{\infty\}$ with the map $(s_i, s_j) \mapsto \text{order}(s_i s_j) = e$ which gives rise to the relations, R , defined as:

$$R = \{(s_i s_j)^{m_{ij}} \mid m_{ij} \in \{1, 2, \dots, \infty\}, m_{ij} = m_{ji}, m_{ij} = 1 \iff i = j\}$$

Lemma 1.1.2. W is a group.

Proof. Elements of W are words with respect to S , and the operation is concatenation. The identity is the empty word and the inverse for any word $s_1 s_2 \dots s_k \in W$ is $s_k s_{k-1} \dots s_2 s_1 \in W$, due to $s_i^2 = e$. Formally, take $W = F/N$ with F the free group generated by S and N the normal subgroup generated by $\{(s s')^{m(s,s')} = e\}$. \square

We now give a definition of what it means to be an irreducible Coxeter group. This paper will mainly focus on irreducible Coxeter groups unless otherwise specified.

Definition 1.1.3. A *connected component* of M is a maximal subset J of $[n]$ (maximal in the sense that no other vertex can be added to it) such that $m_{jk} = 2$ for each $j \in J$ and $k \in [n] \setminus J$. In the graph M , this means that j and k have no edge between them. If M has a single connected component, it is called *connected* or *irreducible*. A Coxeter group W over a Coxeter diagram M is called irreducible if M is connected.

We will assume that S is finite for the rest of this paper.

All finite irreducible Coxeter groups have been classified.[13] The proof is out of the scope for this paper. For the interested reader, seeing the proofs in [1] should be more than sufficient for finite irreducible Coxeter groups.

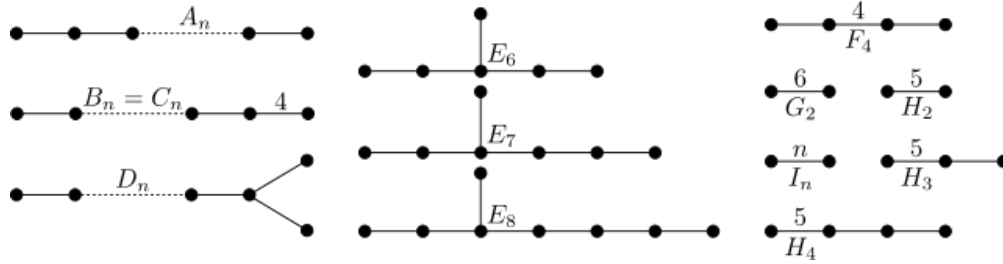

Figure 1.2. Finite Irreducible Coxeter Groups [22]

Proof for the classification of affine irreducible Coxeter groups is given by [15].

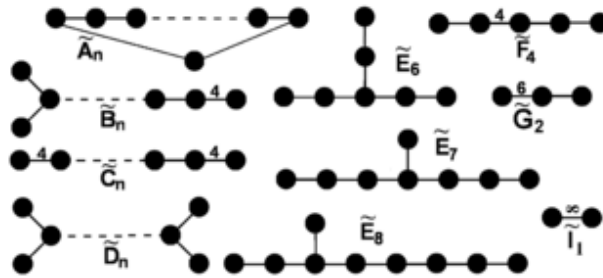

Figure 1.3. Affine Irreducible Coxeter Groups [22]

Definition 1.1.4. A **Coxeter diagram** is built by the function $m : S \times S \rightarrow \{\mathbb{N} \setminus 0\} \cup \{\infty\}$ where

$$(s, s') \mapsto \begin{cases} \text{the vertex of } s, & \text{if } m(s, s') = 1 \\ \text{not connected by an edge,} & \text{if } m(s, s') = 2 \\ \text{connected by an edge,} & \text{if } m(s, s') = 3 \\ \text{connected by a line with weight label,} & \text{if } m(s, s') \geq 4 \end{cases}$$

Theorem 1.1.5. A Coxeter system is in a one-to-one correspondence with a Coxeter diagram.

Proof. This is immediate by the construction of the Coxeter system and the Coxeter diagram via its $n \times n$ -symmetric matrix representation. \square

Example 1.1.6. Take the following Coxeter diagram:

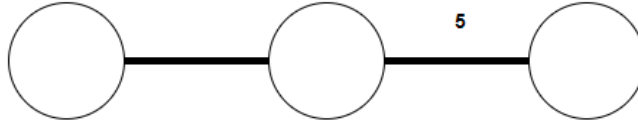

Figure 1.4. Coxeter Diagram

We obtain matrix representation via our generator relations where the vertices are our generators and edges between vertices are our relations. We label the columns and rows of the matrix by the generators s_1, s_2, s_3 in increasing index order left to right and top to bottom. We then write the edge relations between two vertices into the matrix as shown on the next page.

$$M = \begin{bmatrix} 1 & 3 & 2 \\ 3 & 1 & 5 \\ 2 & 5 & 1 \end{bmatrix}$$

Example 1.1.7. The group S_{n+1} can be represented by type A_n where the vertices of A_n are the transpositions of S_{n+1} such that the vertex $s_i = (i, i + 1), 1 \leq i \leq n$ in the Coxeter diagram of type A_n . The edges of type A_n represent the relations between the generators. Recall that the presentation of S_{n+1} can be given as

$$S_{n+1} \cong \langle s_1, s_2, \dots, s_n \in S \mid s_i^2 = e, s_i s_j = s_j s_i \text{ if } |i - j| \geq 2, s_i s_j s_i = s_j s_i s_j \text{ if } |i - j| = 1 \rangle_{i,j=1}^n$$

Given this, it may be hard to consider if S_{n+1} is a Coxeter group. Luckily, Matsumoto and Tits have laid the ground work to prove what is a Coxeter group. The proof will be given later. We begin with some properties of a Coxeter system (W, S) with regards to the set

$$T := \{wsw^{-1} \mid w \in W, s \in S\}.$$

Each element in T is called a *reflection*. Observe that $S \subseteq T$, and $t^2 = e$ for all $t \in T$.

Definition 1.1.8. [1] We define an injective group homomorphism $\pi : W \rightarrow S_B^T$, where S_B^T is the hyperoctahedral group, recalling the relation $-\pi(i) = \pi(-i)$, such that

$$\pi_s(t) = \begin{cases} sts, & \text{if } s \neq t \\ -s, & \text{if } s = t \end{cases}$$

Define the $sgn_s(t) = (-1)^{n(s_1 s_2 \dots s_k, t)}$, where $n(s_1 s_2 \dots s_k, t) =$ number of times $t = s_1 s_2 \dots s_i \dots s_2 s_1$ for $1 \leq i \leq k$.

The definition of length and a reduced expression for a Coxeter group element will help our proofs out.

Definition 1.1.9. The *length* of $w \in W$ is

$$l(w) = \min\{n \geq 0 \mid w = s_1 \dots s_n \text{ with } s_1, \dots, s_n \in S\}$$

an expression $w = s_1 \dots s_n$ with $n = l(w)$ is called a *reduced expression* for w .

To prove that a given group belongs to a Coxeter system or not, we will establish two important properties of a Coxeter system, the strong exchange property and the deletion property.

Theorem 1.1.10 ([5], **Strong Exchange Property**). *Let (W, S) be a Coxeter system. Suppose $w = s_1 s_2 \dots s_k$ ($s_i \in S$) and $t \in T$. If $l(tw) < l(w)$, then $tw = s_1 \dots \hat{s}_i \dots s_k$ for some $i \in [k]$. If $t \in S$, we call this the exchange property.*

Notation 1.1.11. The hat on-top of a generator, \hat{s}_i means that the generator is dropped from the word.

Proof. Let (W, S) be a Coxeter system. Let $w \in W$, and $t \in T$. It will be sufficient to show that $l(tw) < l(w) \iff sgn_{w^{-1}}(t) = -1$ since

$$l(w) = |\{t \in T \mid l(tw) < l(w)\}| = |\{t \in T \mid sgn_{w^{-1}}(t) = -1\}|.$$

\Leftarrow Choose a reduced expression $w = s_1 s_2 \dots s_k$ then $w^{-1} = s_k \dots s_2 s_1$. Since the parity of $sgn_{w^{-1}}(t)$

is odd, $t = s_1 \dots s_i \dots s_1$ for some $1 \leq i \leq k$. Thus,

$$l(tw) = l(s_1 \dots \hat{s}_i \dots s_k) < k = l(w).$$

\Rightarrow Assume that $l(tw) < l(w)$ with $sgn_w(t) = 1$. Then, $l(tw) < l(ttw)$.

$$\pi_{(tw)^{-1}}(t) = \pi_{w^{-1}t}(t) = \pi_{w^{-1}}(-t) = -\pi_{w^{-1}}(t) = -(\pm w^{-1}tw) = -((-1)^{n(w^{-1},t)}w^{-1}tw) = -(\pm w^{-1}tw)$$

which implies $sgn_{w^{-1}}(t) = -1$ since $sgn_w(t) = 1$. \square

Lemma 1.1.12. $l(sw) = l(w) \pm 1$

Proof. Let $w = s_1 \dots s_k$ be a reduced expression for w . If sw is reduced, clearly $l(sw) = l(w) + 1$. If sw is not reduced, then by the exchange property $sw = s_1 \dots \hat{s}_i \dots s_k$ for some i . This is a reduced expression for sw , else if $w = s(sw)$ would be expressible as a word of length less than k , which is a contradiction. \square

Proposition 1.1.13 ([5], **Deletion Property**). *If $w = s_1 s_2 \dots s_k$ and $l(w) < k$, then $w = s_1 \dots \hat{s}_i \dots \hat{s}_j \dots s_k$ for some $1 \leq i < j \leq k$.*

Proof. Choose i to be a maximal index so that $s_i s_{i+1} \dots s_k$ is not reduced. Then, $l(s_i s_{i+1} \dots s_k) < l(s_{i+1} \dots s_k)$ $l(s_{i+1} \dots s_k) = k - i$, and $l(s_i s_{i+1} \dots s_k) \neq k - i + 1$.

Thus, $l(s_i s_{i+1} \dots s_k) = k - i - 1 = l(s_{i+1} \dots s_k) - 1$. Now, by the exchange property, we have

$$s_i s_{i+1} \dots s_k = s_{i+1} \dots \hat{s}_j \dots s_k$$

$$s_1 s_2 \dots s_{i-1} s_i s_{i+1} \dots s_k = s_1 s_2 \dots s_{i-1} \hat{s}_i s_{i+1} \dots \hat{s}_j \dots s_k$$

\square

Example 1.1.14. For an example of the strong exchange property, consider $(W, S) = (A_4, \{s_1, s_2, s_3, s_4\})$ with $w = s_3 s_4 s_3 s_4 s_2 s_3 s_1$ and consider its wiring diagram. We do the wiring diagram right to left with respect to the word w . One can see that $l(s_4 w) < l(w)$ since one will see that the strings of 1 and 5 double cross, or because $m_{3,4} = 3$. This means we can straighten the lines where they cross to reduce to the word $w' = s_3 s_2 s_3 s_1$.

For the deletion property, see that wires 3 and 5 are double crossing, giving the word $w'' = s_4s_3s_2s_3s_1$.

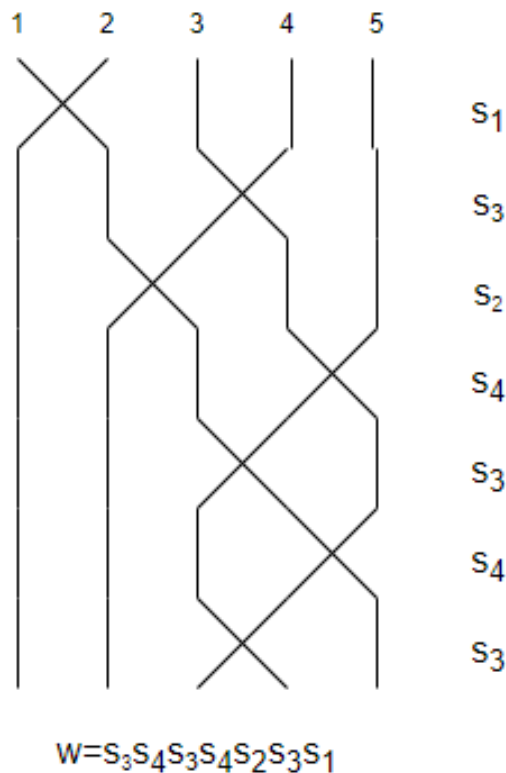

Figure 1.5. String Diagram

One can use the hyperoctahedral group defined before to establish that looking at the pre-images of a pair of wires, if they cross an even number of times, one can then straighten out the wires where they intersect. If looking just in S_n , one can look at the number of *inversions* of a permutation w , i.e. the number of pairs (i, j) such that $i < j$ where $w_i > w_j$. The number of inversions is also equivalent to $l(w)$.

Lemma 1.1.15 ([5], Corollary 1.4.8). *By properties of the exchange property and deletion property we obtain*

1. *Any expression $w = s_1s_2\dots s_k$ contains a reduced expression for w as a subword, which is obtainable by deleting an even number of letters.*
2. *Suppose $w = s_1s_2\dots s_k = s'_1s'_2\dots s'_k$ are two reduced expressions. Then the set of letters in the first word equals the set of letters appearing in the second word.*

3. No Coxeter generator element can be expressed in the terms of other Coxeter generator elements.

Proof. 1. This is a result from the deletion property.

2. Suppose we have that $s_j \notin \{s'_1, \dots, s'_k\}$ where j is a minimal element with this property. We must have that

$$s_1 s_2 \dots s_j \dots s_2 s_1 = s'_1 s'_2 \dots s'_i \dots s'_2 s'_1 \text{ for some } i.$$

Thus,

$$s_j = s_{j-1} \dots s_1 s'_1 s'_2 \dots s'_i \dots s'_1 s_1 \dots s_{j-1}.$$

On the right-hand side, all the generators belong to $\{s'_1, \dots, s'_k\}$ which implies that s_j also is by a reduced subword. This is a contradiction by our assumption.

3. Using 1, 2 \Rightarrow 3. Suppose $s_i \neq s_k$ for some $i \neq k$ such that $s_i, s_k \in S \setminus \{s\}$. Suppose $s = s_1 \dots s_k \in S \setminus \{s\}$. Then shortening by part 1, $s = s_i \in S \setminus \{s\}$ gives us a contradiction. □

Theorem 1.1.16 ([5][17], Theorem 1.5.1). *Take (W, S) to be a Coxeter system where all generators have order 2. Then the following are equivalent:*

1. (W, S) is a Coxeter system.
2. (W, S) has the exchange property.
3. (W, S) has the deletion property.

Proof. (1) \Rightarrow (2): Proven.

(2) \Rightarrow (3): Proven.

(3) \Rightarrow (2):

Let $w = s_1 \dots s_k$ be a reduced expression. Suppose that $l(sw) < l(w) = k$. By the deletion property we have two options for sw :

$$sw = \begin{cases} s s_1 \dots \hat{s}_i \dots \hat{s}_j \dots s_k \\ \hat{s} s_1 \dots \hat{s}_i \dots s_k \end{cases}$$

We claim the first option is not possible. If $w = s_1 \dots \hat{s}_i \dots \hat{s}_j \dots s_k$ for which $l(w) = k-2 < k-1 = l(sw)$, this is a contradiction. Thus, we must have s as one of the deleted generators. This implies we have $sw = \hat{s}s_1 \dots \hat{s}_i \dots s_k = s_1 \dots \hat{s}_i \dots s_k$.

(2) and (3) \Rightarrow (1):

Let (W, S) be a Coxeter system. We know the generators of our group W , S where our generators satisfy (2) and (3) with having order two for each generator of our group W . Let $m(s, s') =$ order of ss' in W . We claim that W is the Coxeter group for S , and our matrix m . We will need to show that:

- S generates W . This is guaranteed by the assumption of our theorem.
- W satisfies the Coxeter relations $(ss')^{m(s, s')} = e$. Guaranteed by our assumption.
- W has no other relations, in other words $s_1 s_2 \dots s_k = e$ is a consequence of Coxeter relations.

Suppose there exists some relation $s_1 \dots s_t = e$ be a relation in a group with the exchange and deletion property. We shall induct on t . By the deletion property, we have that $t = 2k$ where $k \in \mathbb{Z}^+$. Now, rewriting our original relation we have

$$s_1 \dots s_k = s'_1 \dots s'_k$$

moving the right to the left, it will suffice to show that $(ss')^{m(s, s')} = e$ for which $m(s, s')$ is the order of the product of ss' whenever this is finite. We define a relation being **fine** if $(ss')^{m(s, s')} = e$ holds. We assume that all relations less than $2k$ are fine. We now induct on k with the realization that $k=1$ is trivial. We split into two different cases.

Case I: Suppose $s_1 \dots s_k$ is not reduced. Take a max index i for which $s_i \dots s_k$ is not reduced where $s_{i+1} \dots s_k$ is reduced. Since $k - i - 1 = l(s_i \dots s_k) < l(s_{i+1} \dots s_k) = k - i$, by the exchange property we have

$$s_i s_{i+1} \dots s_k = s_{i+1} \dots \hat{s}_j \dots s_k$$

$$s'_1 \dots s'_k = s_1 \dots s_{i-1} s_i s_{i+1} \dots s_k = s'_1 \dots \hat{s}_i \dots \hat{s}_j \dots s'_k.$$

The second equality on the second line is a byproduct of Coxeter relations. By assumption we have the first equality on the second line holds by our assumption given. Similarly, the first and third word of the second line are hold by our Coxeter relations. This shows that $s_1 \dots s_k = s'_1 \dots s'_k$ is fine since the relation is now lowered in length.

Case II: Suppose $s_1 \dots s_k$ is reduced. Assume $s_1 \neq s'_1$.

$$\begin{aligned} s_1 \dots s_k &= s'_1 \dots s'_k \\ s'_1 s_1 \dots s_k &= s'_2 \dots s'_k \\ k - 1 &= l(s'_1 s_1 \dots s_k) < l(s'_2 \dots s'_k) = k. \end{aligned}$$

By the exchange property,

$$\begin{aligned} s'_1 s_1 \dots s_k &= s_1 \dots \hat{s}_i \dots s_k \\ s'_1 \dots s'_k &= s_1 \dots s_k = s'_1 s_1 \dots \hat{s}_i \dots s_k. \end{aligned}$$

The first and third word are equivalent since $s'_2 \dots s'_k = s_1 \dots \hat{s}_i \dots s_k$ which is shorter which implies it is a byproduct of Coxeter relations. In a similar fashion, for the second word equaling the third word we have that $s_1 \dots s_i = s'_1 s_1 \dots s_{i-1}$. This is shorter than original and multiply both sides by Coxeter relations. This holds for all $i < k$. We shall now consider when $i = k$.

If $i = k$, take $s_1 \dots s_k = s'_1 \dots s'_k$. If this is a result from Coxeter relations we are done. Else, reduce to prove that $s'_1 s_1 \dots s_k = s_1 \dots s_{k-1}$. By doing the same process as before, we will receive $s'_1 s_1 \dots s_{k-1} = s_1 s'_1 s_1 \dots s_{k-2}$. If this is a resultant of Coxeter relations we are done. Else, reduce to prove that $s_1 s'_1 s_1 \dots s_{k-2} = s'_1 s_1 \dots s_{k-1}$. We iterate until we get to the reduced relation of

$$s_1 s'_1 s_1 s'_1 \dots = s'_1 s_1 s'_1 s_1 \dots$$

□

Seeing the end of this theorem brings rise to Matsumoto's Theorem.

Theorem 1.1.17 ([17], **Matsumoto's Theorem**). *If two reduced words $w, w' \in W$ represent the same element $\tilde{w} \in W$ of a Coxeter group, then the first word can be transformed into the second by repeatedly transforming $xyxy\dots$ to $yxyx\dots$ (or vice versa) where $xyxy\dots = yxyx\dots$ is one of the defining relations of the Coxeter group.*

Now that we can deduce what is and is not a Coxeter group through the deletion and exchange property, it would be nice to have a way to represent elements and tell what their word length is. As one sees in a Combinatorics course, looking at posets is the way to go.

2. POSETS AND ROOT SYSTEMS

2.1. Posets

We will mainly be concerned about the right weak order Bruhat order unless otherwise stated. Again, this section is for the reader who is not experienced with [5]. We begin this section by defining a poset.

Definition 2.1.1. A partially ordered set (*poset*) is a set S with a partial order \leq , such that:

1. For all $x, y \in S$, if $x \leq y$, and $y \geq x$ then $x = y$. (Anti-symmetric)
2. For all $x, y \in S$, if $x \leq y$, and $y \leq z$, then $x \leq z$. (Transitive)
3. For all $x \in S$, $x \leq x$. (Reflexive)

We can also define a poset structure on a Coxeter system with its reflection set T .

Definition 2.1.2. Let (W, S) be a Coxeter system and $T = \{wsw^{-1} \mid w \in W, s \in S\}$ be the set of reflections. Let $u, v \in W$. The *Bruhat graph* is the directed graph whose nodes are the elements of W and whose edges are given by (1). The *Bruhat order* is the partial order relation on the set W defined by (2).

1. For all $u, v \in W$, $u \rightarrow v$ if $v = ut$ for some $t \in T$ where $l(v) > l(u)$.
2. For all $u, v \in W$, $u \leq v$ if $u = u_0 \rightarrow u_1 \rightarrow \dots \rightarrow u_k = v$ for some $u_i \in W$.

Example 2.1.3. For S_3 , we have that $T = \{s_1 = (1, 2), s_2 = (2, 3), (1, 3)\}$ when checking all of the elements of S_3 . Thus, we achieve the second figure. When T is dropped, we achieve the first figure when concatenating elements on the right hand side. This is called the *right weak Bruhat order*. We denote the covering relation as $u \leq_R v$ for the weak right Bruhat order and $u \leq_R v$ for $u, v \in W$.

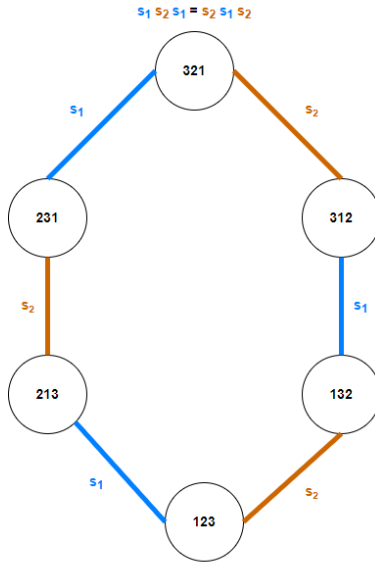

Figure 2.1. Weak Right Bruhat Order of S_3

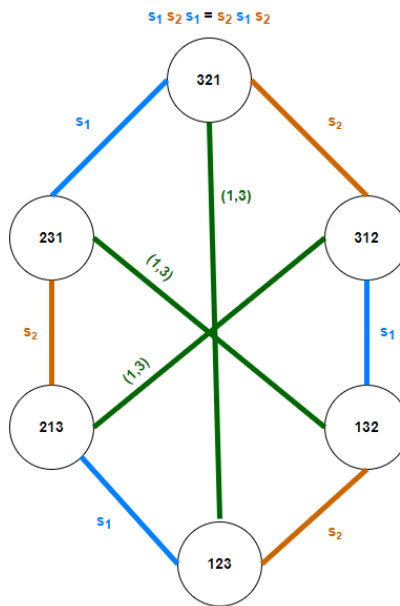

Figure 2.2. Strong Bruhat Order of S_3

Here are some obvious properties of the Bruhat order:

Corollary 2.1.4. *Let (W, S) be a Coxeter system. For the Bruhat order we have*

1. $u < v \Rightarrow l(u) < l(v)$, $u, v \in W$.
2. $u < ut \iff l(u) < l(ut)$, for all $u \in W$ and $t \in T$.

3. The identity element e satisfies $e \leq w$ for all $w \in W$.

Theorem 2.1.5 ([5], **Subword Property**). *Let $w = s_1s_2\dots s_q$ be a reduced expression. Then, $u \leq w \iff$ there exists a reduced expression $u = s_{i_1}s_{i_2}\dots s_{i_k}$, where $1 \leq i_1 < \dots < i_k \leq q$.*

Theorem 2.1.6 ([5], **Chain Property**). *If $u < v$, then there exists a chain $u = x_0 < x_1 < \dots < x_k = v$ such that $l(x_i) = l(u) + i$, for $1 \leq i \leq k$.*

Recall that a poset is *graded* if all maximal chains have the same length. *Maximal chains* are not contained in any other chain properly. Observe that the weak right Bruhat order of S_3 has two maximal chains of size three. Also note that not all posets are graded.

Corollary 2.1.7. *The Bruhat order is graded by length.*

Proof. Immediate by the chain property. □

There are also some non-obvious properties we have, as proved in [5].

Theorem 2.1.8 ([5], **Lifting Property**). *If $u, v \in W, s \in S, u < v, u < su, v > sv$ then $u \leq sv$ and $su \leq v$.*

Lemma 2.1.9. [1] *Let $u, v \in W$, then there exists $w \in W$ with $u \leq w$ and $v \leq w$.*

Corollary 2.1.10. [1] *In a finite Coxeter group there exists a unique maximal element, w_0 which is called the long word, denoted w_0 .*

Proposition 2.1.11 ([5], Proposition 2.3.2). *For a finite Coxeter group, w_0 has the following properties:*

1. $w_0^2 = e$.
2. $l(ww_0) = l(w_0) - l(w)$.
3. $T_L(ww_0) = T - T_L(w)$, for all $w \in W$, where $T_L(w) = \{t \in T \mid tw < w\}$.
4. $l(w_0) = |T|$.

2.2. Root Systems

The goal of this section is to construct what is called a root poset out of our Coxeter system. We then observe a special type of root, the small roots of our Coxeter system, that will be crucial in constructing our automaton. For the sake of brevity, we skip over the notions of parabolic subgroups in this section, consequently skipping over some proofs. This section is for the reader who is not familiar with root systems or [5].

Definition 2.2.1. Let (W, S) be a Coxeter system with n generators. Define $\Delta := \{\alpha_1, \alpha_2, \dots, \alpha_n\}$ to be the *simple roots* which associates each generator s_i to a simple root α_i . This forms a basis for V as a finite dimensional $\mathbb{R}^{|S|}$ vector space of size $|S|$. For this vector space, we will equip the bilinear form $\langle \cdot, \cdot \rangle : V \times V \rightarrow \mathbb{R}$ defined by $\langle \alpha_i, \alpha_j \rangle = -\cos(\frac{\pi}{m(s_i, s_j)})$. Observe that $\langle \alpha_i, \alpha_j \rangle = 1$ when $i = j$ and $\langle \alpha_i, \alpha_j \rangle \leq 0$ for all $i \neq j$. If $m(s_i, s_j) = \infty$ then we adopt the convention $\langle \alpha_i, \alpha_j \rangle = -1$.

A root α is *positive* if $\alpha = c_1\alpha_1 + \dots + c_n\alpha_n$, for all $c_i \geq 0$ and *negative* if $\forall c_i \leq 0$. We then can construct a *root system* $\Phi := \{w\alpha_i \mid w \in W, 1 \leq i \leq n\}$. $w\alpha_i$ can be defined through the following linear mapping:

Let $s \in S$, and $\beta \in \Phi$, where $\sigma_s : V \rightarrow V$ by

$$\sigma_s(\beta) := s(\beta) = \beta - 2\frac{\langle \alpha_s, \beta \rangle}{\langle \beta, \beta \rangle} \alpha_s.$$

Since $w = s_1 \dots s_k$ as some reduced word this can be done inductively starting from s_k and working to the left. For the sake of this paper, we will consider only the case where $\langle \beta, \beta \rangle = 1$. Thus, we achieve the resulting formula multiplying a root β , by a generator from the left:

$$s(\beta) = \beta - 2\langle \alpha_s, \beta \rangle \alpha_s \tag{2.1}$$

From this definition, $s\alpha_s = -\alpha_s$, $\sigma_s^2(\beta) = \beta$, and $\langle w(\alpha), w(\beta) \rangle = \langle \alpha, \beta \rangle$ by pure calculation. Since concatenating by a word on both sides gives the same bilinear form back, we have that all the roots are unit vectors. This gives us the consequence that if $\beta, \gamma \in \Phi$ and $\gamma = r\beta$ for some $r \in \mathbb{R}$. then $r \in \{+1, -1\}$. We give a table of root systems associated to a few finite irreducible Coxeter groups.

Example 2.2.2. Let $V = \mathbb{R}^n$ with the standard basis consisting of the column vectors e_i with a one in the i -th position and zeros elsewhere: $e_i = (0, \dots, 1, \dots, 0)^t$ with $\langle e_i, e_j \rangle = \delta_{ij}$.

Type	Root System
$A_n (n \geq 2)$	$\{\pm(e_i - e_j) \mid 1 \leq i \neq j \leq n\}$
$B_n (n \geq 2)$	$\{\pm e_i \pm e_j \mid 1 \leq i < j \leq n\} \cup \{\pm e_i \mid 1 \leq i \leq n\}$
$C_n (n \geq 3)$	$\{\pm e_i \pm e_j \mid 1 \leq i < j \leq n\} \cup \{\pm 2e_i \mid 1 \leq i \leq n\}$
$D_n (n \geq 4)$	$\{\pm e_i \pm e_j \mid 1 \leq i < j \leq n\}$

Table 2.1. Non-Exceptional Root Systems

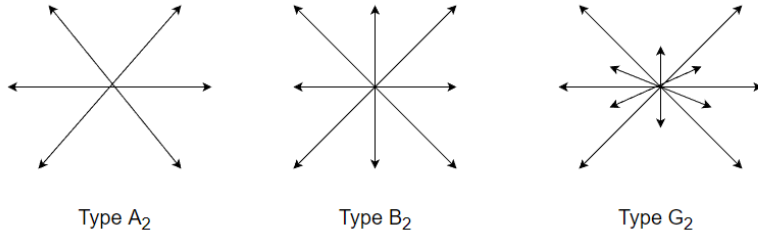

Figure 2.3. Root System Examples

We will need the following technical lemma in the future when constructing our automaton.

Lemma 2.2.3. ([5], Lemma 4.2.4)

If $j < m(s, s')$, then $(\dots s' s s')_j(\alpha_s) = c\alpha_s + d\alpha_{s'}$ for some $c, d \geq 0$.

Proof. For the sake of brevity, see [5]. □

Proposition 2.2.4. ([5], Proposition 4.2.5)

For all $w \in W$ and $s \in S$ the following hold:

1. $l(ws) > l(w)$ implies $w(\alpha_s) > 0$.
2. $l(ws) < l(w)$ implies $w(\alpha_s) < 0$.

Proof. See [5]. The proof is by induction and uses the notion of parabolic subgroups. □

We also get from this proposition the following theorem about our set of roots, Φ . This theorem will help us take a select set of roots, mainly Φ^+ . The roots can never be mixed when considering Φ .

Theorem 2.2.5. ([5], pg. 101) Roots are either positive or negative $\Phi = \Phi^+ \sqcup \Phi^-$.

Proof. See the previous proposition that tells us when a root is positive or negative. □

Example 2.2.6. Consider \mathbb{R}^3 with the standard basis e_1, e_2, e_3 . let $\alpha = e_2 - e_1$ and $\beta = e_1 - e_3$. Then we have $\Phi^+ = \{\alpha, \beta, \alpha + \beta\}$ and $\Phi^- = \{-\alpha, -\beta, -\alpha - \beta\}$ resulting in $\Phi = \Phi^+ \sqcup \Phi^-$.

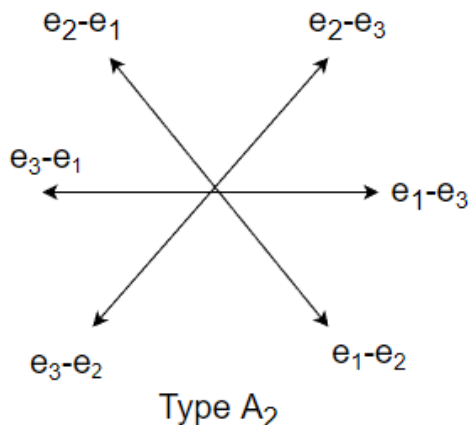

Figure 2.4. Type A_2 Root System

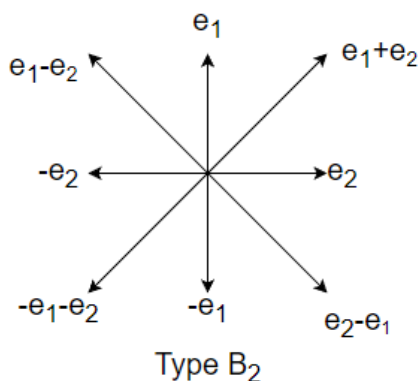

Figure 2.5. Type B_2 Root System

Here are some popular properties about roots that will be used later on.

Proposition 2.2.7. ([5], Lemma 4.4.3, Proposition 4.4.4)

1. Let $s_i \in S$, then s_i sends $\alpha_i \mapsto -\alpha_i$ and permutes the rest of $\alpha_j \in \Phi^+$.
2. Let $w \in W$, then $l(w) =$ the number of positive roots that w sends to negative roots.

Proof. 1. $s_i\alpha_i = -\alpha_i$ is clear. Now take an arbitrary $\gamma \in \Phi^+$ where $\gamma \neq \alpha_i$. Then

$$s_i(\gamma) = (\gamma) - 2\langle \alpha_{s_i}, \gamma \rangle \alpha_{s_i} = \gamma - 2\langle \alpha_{s_i}, \sum_{s \in S} c_s \alpha_s \rangle \alpha_{s_i} \geq 0.$$

Where $c_s \in \mathbb{R}$ for all $s \in S$, and by the addition property of the bilinear form we are done.

2. Let $w, v \in W$. We perform induction on $l(w)$. This is true for all $l(w) \leq 1$. Now, suppose this is true for all lengths less than $l(w)$. Suppose that $w = vs > v$, for some $s \in S$. Then for $\beta \in \Phi^+$ by our previous proposition $w(\beta) \in \Phi^-$ if and only if $\beta = \alpha_s$ or $s(\beta) \in \{\beta \in \Phi^+ : w(\beta) \in \Phi^-\}$. By the induction hypothesis, there are $l(v) + 1 = l(w)$ such elements for $\beta \in \Phi^+$.

□

Example 2.2.8. For type A_2 , as seen in the hyperplane arrangement in example 2.2.6, one can verify the proposition above provided the table below.

Element	$l(w)$	Φ^+
e	0	—
s_1	1	α
s_2	1	β
s_1s_2	2	$\beta, \alpha + \beta$
s_2s_1	2	$\alpha, \alpha + \beta$
$s_1s_2s_1$	3	$\alpha, \beta, \alpha + \beta$

Table 2.2. Permuting Type A_2 Roots

Theorem 2.2.9. $\Phi = W\Delta$

Proof. True by definition. This is because Δ is in bijection with the simple roots of a Coxeter system with n generators. We then can apply words in W starting from the right of the word to the root as done in equation 2.1. We can iterate this process until resulting into some root (γ). Doing this process iteratively, we obtain all the roots of our system. For roots Φ decomposing into $W\Delta$, each root is composed of previous simple roots with an iteration from W . We see that this holds true with the concept of depth giving that our root posets are graded. □

One can measure the rank of a given root by the following definition.

Definition 2.2.10. ([5], Definition 4.6.1) The *depth* of a root $\beta \in \Phi^+$ is the minimum length of a word, w , such that $w\beta < 0$. This is notated

$$dp(\beta) := \min\{k : w(\beta) \in \Phi^- \text{ for some } w \in W \text{ with } l(w) = k\}.$$

We see from the definition that all elements of Δ have the depth of 1. One will see from the next lemma that depth is recursive.

Lemma 2.2.11. ([5], Lemma 4.6.2) Let $s \in S$ and $\beta \in \Phi^+ - \{\alpha_s\}$. Then

$$dp(s\beta) = \begin{cases} dp(\beta) + 1, & \text{if } \langle \beta, \alpha_s \rangle > 0 \\ dp(\beta), & \text{if } \langle \beta, \alpha_s \rangle = 0 \\ dp(\beta) - 1, & \text{if } \langle \beta, \alpha_s \rangle < 0 \end{cases}$$

Proof. We shall argue by cases.

Case I: Suppose $\langle \beta, \alpha_s \rangle = 0$ then $s(\beta) = \beta$. So, $dp(s(\beta)) = dp(\beta)$.

Case II: Suppose $\langle \beta, \alpha_s \rangle > 0$. It is obvious that $dp(s(\beta)) - dp(\beta) \geq -1$. If we can show that $dp(\beta) > dp(s(\beta))$ then we will have $dp(s(\beta)) = dp(\beta) - 1$. Choose a $w \in W$ such that $w(\beta) \in \Phi^-$ and $l(w) = dp(\beta)$ Consider the following subcases where $ws > w$ and $ws < w$.

1. If $ws < w$, then $l(ws) < l(w)$. Choose w such that $ws(s(\beta)) = w(\beta) \in \Phi^-$. Thus, $dp(s(\beta)) \leq l(ws) < l(w) = dp(\beta)$.
2. Assume that $ws > w$. Take into consideration the root

$$\gamma = ws(\beta) = w(\beta - 2\langle \beta, \alpha_s \rangle \alpha_s) = w(\beta) - 2\langle \beta, \alpha_s \rangle w(\alpha_s).$$

Since $w(\beta) \in \Phi^-$, $\langle \beta, \alpha_s \rangle > 0$, and by $l(ws) > l(w)$ $w(\alpha_s) \in \Phi^-$ we have that $\gamma \in \Phi^-$. We observe that $\gamma \neq -\alpha_{s'}$ for all $s' \in S$ since no two negative roots can sum to $-\alpha_{s'}$. Choose $s' \in S$ such that $s'w < w$. then, $s'w(s(\beta)) = s'(\gamma)$ and $s'(\gamma) \in \Phi^-$ by permutation of the root as shown before with $\gamma \in \Phi^- \setminus \{\alpha_{s'}\}$. Now we obtain $dp(s(\beta)) \leq l(s'w) < l(w) = dp(\beta)$.

Case III: Suppose that $\langle \beta, \alpha_s \rangle < 0$. Then we have $\langle s(\beta), \alpha_s \rangle = -\langle \beta, \alpha_s \rangle > 0$. By the previous case, $dp(\beta) = dp(s(s(\beta))) = dp(s(\beta)) - 1$. □

Now that depth has been given, we provide the definition of a root poset.

Definition 2.2.12. ([5], Definition 4.6.3) The *root poset* on Φ^+ is defined by $\beta, \gamma \in \Phi^+$, let $\beta \leq \gamma$ if there exists $s_1, s_2, \dots, s_k \in S$ such that

1. $\gamma = s_k s_{k-1} \dots s_1(\beta)$.
2. $dp(s_i s_{i-1} \dots s_1(\beta)) = dp(\beta) + i$ for all $1 \leq i \leq k$.

Definition 2.2.13. For $\alpha, \beta \in \Phi^+$ we say that β *precedes* α , with the notation $\beta \leq \alpha$, if there is an element $w \in W$ of length $dp(\alpha) - dp(\beta)$ such that $\alpha = w\beta$.

We establish that the root poset has the partial order of \leq .

Lemma 2.2.14. [6] *The relation \leq is a partial order on Φ^+ .*

Proof. Suppose $\alpha, \beta, \gamma \in \Phi^+$ take on the property that $\alpha \leq \beta$ and $\beta \leq \gamma$. There there exists a $v, w \in W$ such that $\beta = w\alpha$, and $\gamma = v\beta$ with the property that $dp(\beta) - dp(\alpha) = l(w)$ and $dp(\gamma) - dp(\beta) = l(v)$. Our goal is to show that $\alpha \leq \gamma$. Looking at $dp(\gamma) - dp(\alpha) = l(u) + l(v)$ and $vw\alpha = \gamma$. Thus, it will suffice to show that $l(vw) = l(v) + l(w)$.

Choose $u \in W$ that satisfies $l(u) = dp(\alpha)$ and $u\alpha \in \Phi^-$. Then we obtain $uw^{-1}v^{-1}\gamma = uw^{-1}\beta = u\alpha \in \Phi^-$ which implies that $l(uw^{-1}v^{-1}\gamma) \geq dp(\gamma)$ Doing the inequality in the reverse direction we achieve the following

$$\begin{aligned} l(uw^{-1}v^{-1}) &\leq l(u) + l(w) + l(v) \\ &= dp(\alpha) + dp(\beta) - dp(\alpha) + dp(\gamma) - dp(\beta) = dp(\gamma) \\ &\leq l(uw^{-1}v^{-1}). \end{aligned}$$

So now we have that $l(uw^{-1}v^{-1}) = l(u) + l(w) + l(v)$.

$$l(uw^{-1}v^{-1}) = l(u(vw)^{-1}) \leq l(u) + l((vw)^{-1}) = l(u) + l(vw)$$

This gives us $l(v) + l(w) \leq l(vw)$, but by triangle inequality we obtain that $l(vw) \leq l(v) + l(w)$. So, $l(vw) = l(v) + l(w)$. Thus, we obtain $\alpha \leq \gamma$.

For reflexivity, it is obvious with the choice of $w = e$.

For anti-symmetric, let $\gamma \leq \alpha$ then $0 \leq dp(\alpha) - dp(\gamma) \leq 0$ which implies $\alpha = \gamma$.

□

Corollary 2.2.15. *The root poset (Φ^+, \leq) has the following properties:*

- *The minimal elements are the simple roots of depth 1.*
- *All maximal chains in an interval have the same length, $dp(\gamma) - dp(\beta)$.*
- *All maximal chains in $\{\beta \mid \beta \leq \gamma\}$ have the same length $dp(\gamma) - 1$. Thus, depth is a rank function.*

There is an algorithmic way to build root posets. We do this in the following manner:

Let $s \in S$ and write $\beta = \sum_{s' \in S} b_s \alpha_{s'}$. Let $k_{s,s'} = 2 \cos(\frac{\pi}{m(s,s')})$ through the expansion of the bilinear form we achieve,

$$s(\beta) = \beta + \left(\sum_{s' \in S} k_{s,s'} b_{s'} \right) \alpha_s$$

Now define

$$B_s = -b_s + \sum_{s': s' - s} k_{s,s'} b_{s'}$$

such that $s' : s' - s$ denotes the elements of $s' \in S$ where s' is adjacent to s in the Coxeter diagram of W . Also, b_s is the coefficient of the s -th coordinate of β .

Claim: $-2\langle \alpha_s, \beta \rangle = B_s - b_s$.

Proof.

$$-2\langle \alpha_s, \beta \rangle = -2\langle \alpha_s, \sum_{s' \in S} b_{s'} \alpha_{s'} \rangle = \sum_{s' \in S} k_{s,s'} b_{s'}$$

$$B_s - b_s = \sum_{s': s' - s} b_{s'} \alpha_{s'} - 2b_s = \sum_{s': s' - s} b_{s'} \alpha_{s'} + k_{s,s'} b_s = \mathbf{LHS}$$

□

We now write $s(\beta) = \beta + (B_s - b_s) \alpha_s$

The following lemma will recognize whether or not $s(\beta)$ is above β .

Lemma 2.2.16. *([5], Lemma 4.6.4) $s(\beta) > \beta \iff B_s > b_s$.*

Proof. An analogous way to state the lemma is found out in Lemma 3.15 of [19].

$$B_s > b_s \Rightarrow dp(s(\beta)) = dp(\beta) + 1$$

$$B_s < b_s \Rightarrow dp(s(\beta)) = dp(\beta) - 1$$

Through the previous definition of the root poset on Φ^+ we come to the conclusion if $s(\beta)$ is above β or not.

If $B_s - b_s > 0$ then we have that $\langle \alpha_s, \beta \rangle = \frac{B_s - b_s}{-2} < 0$. Through the definition of depth we have $dp(s(\beta)) = dp(\beta) + 1$. The second argument is similar to the first. \square

The following proposition tells us succinctly how to generate the root poset.

Proposition 2.2.17. ([24], Proposition 3.16) *Let (W, S) be a Coxeter system with $\Delta \subset \Phi^+$ the simple roots. A partially ordered set on Φ^+ can be constructed as follows.*

1. *Begin with the simple roots $\Delta = \{\alpha_s : s \in S\}$. Set $j = 1$. Then for each root β with depth j and each $s \in S$ such that no s -labelled edge leads down from β , compute the quantity B_s . Note that γ is also just the positive root $s(\beta)$.*
2. *If $B_s = b_s$ do nothing. If $B_s > b_s$, let γ be the vector obtained from β by replacing b_s with B_s in the s -th coordinate of β .*
3. *Then γ is a root of depth $j + 1$ and (β, γ) is an s -labelled edge.*

Example 2.2.18. We first look at the Coxeter system of A_3 . We then obtain the following root poset on $\Phi^+ = \{\alpha_1, \alpha_2, \alpha_3, \alpha_1 + \alpha_2, \alpha_2 + \alpha_3, \alpha_1 + \alpha_2 + \alpha_3\}$ which we list off based on their coordinates in \mathbb{R}^S . However, not all Φ^+ root posets are finite. We shall now define one of the affine irreducible Coxeter groups.

Definition 2.2.19. Fix $n \geq 3$. Let \tilde{A}_{n-1} be the group of all bijections u of \mathbb{Z} to itself such that

- $u(x + n) = u(x) + n$ for all $x \in \mathbb{Z}$
- $\sum_{x=1}^n u(x) = \binom{n+1}{2}$

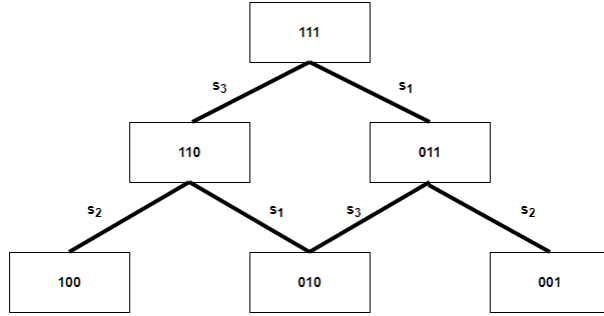

Figure 2.6. Root Poset of A_3

with composition as the group operation where $u = [a_1, \dots, a_n]$ where $u(i) = a_i$ for $i = 1, 2, \dots, n$. This is called *window notation* of u .

Example 2.2.20. Let $\pi = [2, 1, -2, 0, 14]$, and $\sigma = [15, -3, -2, 4, 1]$. Give the two line notation for π and σ . From this calculate $\pi\sigma$.

$$\pi = \left(\begin{array}{cccccccccccc} \dots & -4 & -3 & -2 & -1 & 0 & 1 & 2 & 3 & 4 & 5 & 6 & 7 & 8 & 9 & 10 & \dots \\ \dots & -3 & -4 & -7 & -5 & 9 & 2 & 1 & -2 & 0 & 14 & 7 & 6 & 3 & 5 & 19 & \dots \end{array} \right)$$

$$\sigma = \left(\begin{array}{cccccccccccc} \dots & -4 & -3 & -2 & -1 & 0 & 1 & 2 & 3 & 4 & 5 & 6 & 7 & 8 & 9 & 10 & \dots \\ \dots & 10 & -10 & -7 & -1 & -4 & 15 & -3 & -2 & 4 & 1 & 20 & 2 & 3 & 9 & 6 & \dots \end{array} \right)$$

$$\pi\sigma = [24, -4, -7, 0, 2].$$

The generators for \tilde{A}_{n-1} we take $\tilde{A}_{n-1} = \{\tilde{s}_1, \dots, \tilde{s}_n\}$ where

$$\tilde{s}_i = [1, 2, \dots, i-1, i+1, i, i+2, \dots, n] \text{ for } i = 1, \dots, n-1$$

$$\tilde{s}_n = [0, 2, 3, \dots, n-1, n+1]$$

Multiplying an element $u \in \tilde{A}_{n-1}$ on the right by \tilde{s}_i interchanges the entries of the complete notation of u in positions $i + kn$ and $i + 1 + kn$, for all $k \in \mathbb{Z}$.

$$u\tilde{s}_i = \begin{cases} [u(1), \dots, u(i-1), u(i+1), u(i), u(i+2), \dots, u(n)], & i \in [n-1] \\ [u(0), u(2), \dots, u(n-1), u(n+1)], & i = n \end{cases}$$

Also, this group is given as the following Dynkin diagram:

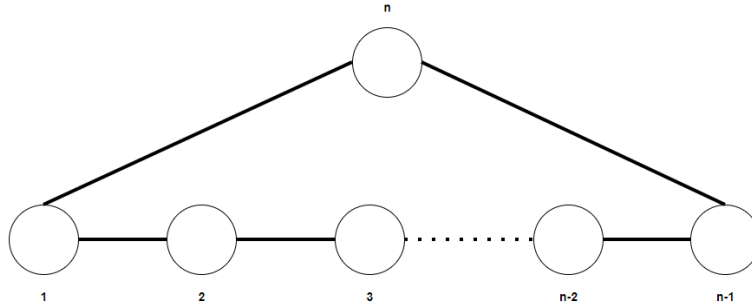

Figure 2.7. Dynkin Diagram of \tilde{A}_{n-1}

Example 2.2.21. Take for example the Coxeter group \tilde{A}_2 . Observe that the red line is a jump of size two. Again, we use the vector notation in $\mathbb{R}^{|S|}$ to correspond to their following roots like in the previous example.

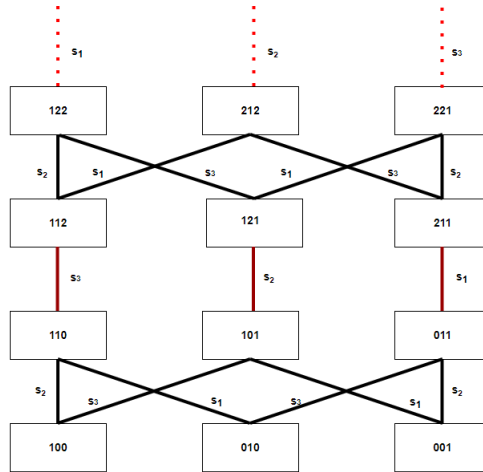

Figure 2.8. Root Poset of \tilde{A}_2

We denote the *covering* of a root by another root by $\beta \triangleleft \gamma$ where there exists a unique $s \in S$ such that $s(\beta) = \gamma$.

2.2.1. Small Roots

We see in our previous example of \tilde{A}_2 can have an infinite amount of positive roots. It would be nice to just take a set of roots which is guaranteed to be finite. To do this, we begin with the following definition.

Definition 2.2.22. We define the *small roots* of (W, S) , denoted Σ as the following subset of Φ^+ where the following hold:

- $\Delta = \{\alpha_s : s \in S\} \subseteq \Sigma$.

- If $\alpha \in \Sigma$, $s \in S$ and $-1 < \langle \alpha, \alpha_s \rangle < 0$, then $s(\alpha) \in \Sigma$.

We call the covering $\beta \triangleleft \gamma$ in the root poset *short* if $|\langle \beta, \alpha_s \rangle| < 1$ where $s \in S$ such that $s(\beta) = \gamma$, otherwise, we call the covering *long*. Since $\langle \gamma, \alpha_s \rangle = -\langle \beta, \alpha_s \rangle$ we have that a root is small if and only if it is reachable from a simple root along an up-directed path of short edges.

It may not be apparent that Σ is finite. We will need two intricate lemmas in order to prove this. We refer to [5] for proofs for both lemmas since they are intricate and involve parabolic subgroups.

Lemma 2.2.23. ([5], Proposition 4.5.5) *There are only finitely many elements in the root poset of any given depth. This set is given by*

$$\{\langle \alpha, \alpha_s \rangle \mid \alpha \in \Phi^+, s \in S, |\langle \alpha, \alpha_s \rangle| < 1\}.$$

Proof. See [5]. □

Example 2.2.24. Seeing the type \tilde{A}_2 root poset example, there are only 3 elements at any given depth.

Lemma 2.2.25. ([5], Lemma 4.7.2) *Let $\beta, \gamma \in \Sigma$ be such that $\beta \triangleleft \gamma$ in the root poset, and $dp(\beta) \geq 2$. Then, $N(\gamma) \subseteq N(\beta)$ where $N(\alpha) := \{s \in S : |\langle \alpha, \alpha_s \rangle| < 1\}$.*

Proof. See [5]. □

Example 2.2.26. Take the root poset of type \tilde{A}_2 . with $\beta = \tilde{s}_2 \tilde{s}_1$ and $\gamma = \tilde{s}_3 \tilde{s}_2 \tilde{s}_1$. Then $N(\gamma) \subset N(\beta)$.

We now obtain a crucial result in the field of Coxeter groups with the two lemmas above.

Theorem 2.2.27. ([5], Theorem 4.7.3) $|\Sigma| < \infty$.

Proof. Suppose for the sake of contradiction that $|\Sigma| = \infty$. We will need the two lemmas above in order to help verify this ubiquitous fact. Since we have Σ , there exists a small root denoted α which has an arbitrarily large depth. Since α is small we obtain a saturated chain in the root poset from some simple root $\alpha_k \mapsto \alpha$.

Recall that a subset $C \subseteq P$ (or P itself) is called a *chain* if its elements are pairwise comparable. Thus every finite chain is of the form $C = \{x_0, \dots, x_n\}$, where $x_0 < \dots < x_n$. The number n is called the length of the chain; observe that the length is one less than the cardinality of the chain. The chain C is called *saturated* if $x_0 \triangleleft \dots \triangleleft x_n$ with $x_i \triangleleft x_{i+1}$ meaning x_i covers x_{i+1} for all indices such that $1 \leq i \leq n-1$.

Through the lemma previously stated, there exist only finitely many pairs (J, v) with $J \subseteq S$ and $v \in \mathbb{R}^{|J|}$, such that there exists a $\gamma \in \Sigma$ with $N(\gamma) = J$ and $(\langle \gamma, \alpha_s \rangle)_{s \in J}$. Take C to be a saturated chain in $\Sigma - \Delta$ of length greater than the number of such pairs. Looking at a segment of C we see that there exists a saturated chain $\gamma_j \triangleleft \gamma_{j+1} \triangleleft \dots \triangleleft \gamma_k$ such that $N(\gamma_j) = N(\gamma_k)$ for some j and

$$\langle \gamma_j, \alpha_s \rangle = \langle \gamma_k, \alpha_s \rangle \text{ for all } s \in N(\gamma_k), \text{ with } dp(\gamma_i) = i \text{ for } i = j, \dots, k.$$

Let $s_i \in S$ be such that $s_i(\gamma_i) = \gamma_{i+1}$ for $i = j, \dots, k-1$. By the second lemma, we also have that $s_j, s_{j+1}, \dots, s_{k-1} \in N$ where $\gamma_{j-1} = s_{k-1}(\gamma_j)$ for all $s \in N$:

$$\begin{aligned} \langle \gamma_{j-1}, \alpha_s \rangle &= \langle s_{k-1}(\gamma_j), \alpha_s \rangle \\ &= \langle \gamma_j, s_{k-1} \alpha_s \rangle \\ &= \langle \gamma_j, \alpha_s - 2\langle \alpha_{s_{k-1}}, \alpha_s \rangle \alpha_{s_{k-1}} \rangle \\ &= \langle \gamma_k, \alpha_s - 2\langle \alpha_{s_{k-1}}, \alpha_s \rangle \alpha_{s_{k-1}} \rangle \\ &= \langle \gamma_k, s_{k-1} \alpha_s \rangle \\ &= \langle s_{k-1} \gamma_j, \alpha_s \rangle \\ &= \langle \gamma_{k-1}, \alpha_s \rangle \end{aligned}$$

By $\gamma_{k-1} \triangleleft \gamma_k$ we have by the depth that $\gamma_{j-1} \triangleleft \gamma_j$. Now the saturated chain of roots is extended from (γ_j, γ_k) to $(\gamma_{j-1}, \gamma_{k-1})$. Through construction we obtain a saturated chain $\gamma_1 \triangleleft \gamma_2, \dots \triangleleft \gamma_j \triangleleft \dots \triangleleft \gamma_k$ in the root poset where γ_1 is a simple root, and

$$\langle \gamma_1, \alpha_s \rangle = \langle \gamma_{k-j+1}, \alpha_s \rangle \text{ for all } s \in N.$$

Take $r \in S$ where $\gamma_1 = \alpha_r$. If $r \in N$ then

$$\langle \gamma_{k-j+1}, \alpha_r \rangle = \langle \gamma_1, \alpha_r \rangle = 1$$

but we must have $|\langle \gamma_{k-j+1}, \alpha_r \rangle| < 1$. This is a contradiction. If not, take $j \leq i \leq k-1$ such that $s_i(\gamma_{k-j}) = \gamma_{k-j+1}$. Then $r \neq s_i$ and

$$0 \geq \langle \gamma_1, \alpha_{s_i} \rangle = \langle \gamma_{k-j+1}, \alpha_{s_i} \rangle > 0$$

which is also a contradiction. \square

Definition 2.2.28. Let $\beta, \gamma \in \Phi^+$. we say that β *dominates* γ denoted $\beta \text{ dom } \gamma$. If $w(\beta) < 0$ implies $w(\gamma) < 0$ for all $w \in W$.

Lemma 2.2.29. ([5], Lemma 4.7.4) Let $\beta \in \Phi^+$ and $s \in S$. Then, $\beta \text{ dom } \alpha_s$ if and only if $\langle \beta, \alpha_s \rangle \geq 1$.

Proof. See [5]. \square

The relation between long and short roots with respect to dominance gives us the property of humble. A positive root is said to be *humble* if the root dominates no positive root except itself. The following lemma is a consequence.

Lemma 2.2.30. ([5], Lemma 4.7.5) Let $\beta, \alpha \in \Phi^+$ be such that $\beta \triangleleft \alpha$ in the root poset. Then we have that the following hold:

- If $\beta \triangleleft \alpha$ is long, then α is not humble.
- If $\beta \triangleleft \alpha$ is short, then α is humble if and only if β is humble.

Proof. Let $s \in S$ be such that $\alpha = s(\beta)$. Assume that the first point holds. Then $\langle \alpha, \alpha_s \rangle \geq 1$. Thus, by the last lemma, we have that α dominates α_s . Therefore, α is not humble.

Assume that the second condition holds. Then $0 > \langle \beta, \alpha_s \rangle > -1$. Take $\gamma \in \phi^+ \setminus \{\beta\}$ such that $\beta \text{ dom } \gamma$. By the previous lemma, $\gamma \neq \alpha_s$. Hence $s(\beta) \text{ dom } s(\gamma)$ and $s(\gamma) \in \Phi^+ \setminus \{s(\beta)\}$ so β is humble if α is humble. A similar argument holds for the other case. \square

The following theorem will allow us to see that humble roots are small roots when the root is part of a positive root poset.

Theorem 2.2.31. ([5], Theorem 4.7.6) *Let $\alpha \in \Phi^+$. Then, $\alpha \in \Sigma$ if and only if α is humble.*

Proof. Let $\alpha \in \Sigma$. Then, α has some saturated chain C in the root poset where each edge is short. This chain is constructed through some simple root $\alpha_1 \in \Delta$ to α . Every simple root is humble. Thus, by the second part of the previous lemma we are done.

Suppose that α is humble and let $\alpha_1 \triangleleft \alpha_2 \triangleleft \dots \triangleleft \alpha_p = \alpha$ be a saturated chain in the root poset from the simple root of $\alpha_1 \in \Delta$ to α . By the previous lemma we obtain that $\alpha_{k-1} \triangleleft \alpha_k$ is short which gives us that α_{k-1} is humble. Therefore, we obtain that all the edges are short between the roots in our chain up to α_k . Set $\alpha_k = \alpha \in \Sigma$. □

We recall from Combinatorics the definition of an order ideal.

Definition 2.2.32. A set I is an *order ideal* of a poset P if $I \subseteq P$ and for all $x \in I$ and $y \in P$, if $y \leq x$, then $y \in I$.

Corollary 2.2.33. ([5], Corollary 4.7.7) *Σ is an order ideal in the root poset.*

Proof. Take $\alpha \in \Sigma$ and $\beta \in \Phi^+$ such that $\beta \triangleleft \alpha$. By the previous theorem, α is humble which gives that $\beta \triangleleft \alpha$ is short and β is humble by the previous lemma. Also, by the last theorem, we obtain that $\beta \in \Sigma$. □

It is an exercise in ([5], exercise 4.19) to show that all positive roots are small for finite Coxeter groups found out by [6]. This gives an answer to the reason why every order ideal in the root poset of A_n are only made out of positive roots.

It is true that all Coxeter groups contain small roots. Unfortunately, not all Coxeter groups are restricted to small roots.

Example 2.2.34. \tilde{A}_2 is a Coxeter group where some of the roots are not small. Recall the diagram given before where the red lines showing that the root comparisons are long. Computations with respect to the simple roots of \tilde{A}_2 produce $\langle \alpha_i, \alpha_i \rangle = 1$, and $\langle \alpha_i, \alpha_j \rangle = \frac{-1}{2}$ where $i \neq j$.

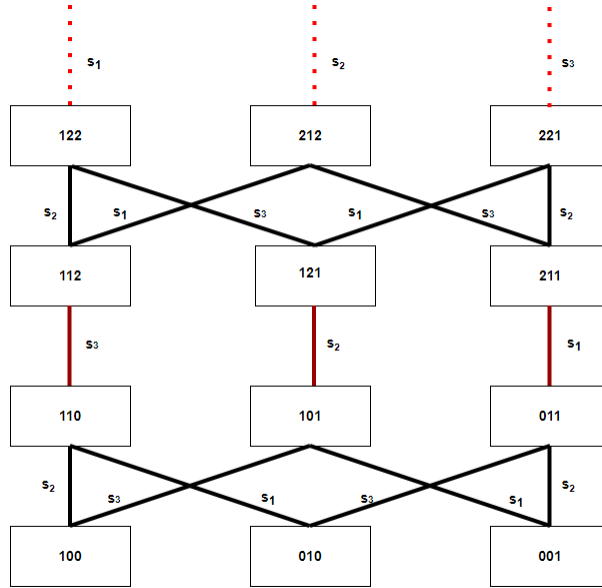

We obtain that the small roots are

$$\{\alpha_1, \alpha_2, \alpha_3, \alpha_1 + \alpha_2, \alpha_2 + \alpha_3, \alpha_1 + \alpha_3\}.$$

With the basics of root posets and having a finite set through small roots we are now ready to begin to construct a finite state automaton for our affine irreducible Coxeter groups.

3. AUTOMATA OF COXETER GROUPS

It may come as a surprise to many that Automata Theory, which studies abstract machines and the computational problems that solve them, and Coxeter groups can be closely related. A bit of research has been developed over the past hundred years in this subject area. In consideration for the word problem for a general group the problem is undecidable. Pyotr Novikov in 1955 showed that there exists a finitely presented group such that the word problem for it is undecidable and won the Lenin prize in 1957 for this result.[18] However, for Coxeter groups, this is decidable![6] We will have to develop some theory going back and forth between Coxeter groups and walks on graphs to count reduced words of length n .

3.1. Automata

Definition 3.1.1. Let W be a finitely generated group. Take a free monoid S^* by $S = \{s_1, \dots, s_n\}$. Thus, $S^* = \cup_{m=0}^{\infty} \{a_1 \dots a_m \mid a_i \in S\}$. Define a *formal language*, L , to be a subset of the set S^* in a given finite alphabet S . A *finite state automaton* (f.s.a) notated \bar{A} is a quintuple (T, A, μ, Y, t_0) , where T is a finite set, called the *state set*. A is a finite set called the *alphabet*, $\mu : T \times A \rightarrow T$ a function called the *transition function*, $Y \subset T$ is the set of *accepted states*, and t_0 is the *initial state*. We say that a word $w \in L$ is *accepted* by the automaton S if the sequence of edge labels along some directed path from the start node equals w , otherwise w is rejected. A language L is *recognized* by the automaton S if the words of L are precisely those that are accepted by S . A language is *regular* if it is recognized by some finite state automaton.

Example 3.1.2. In the case for Coxeter groups we now consider the following for the quintuple stated above

T = The set of nodes of a directed graph.

$A = S$. The Coxeter group's generators.

μ = The function of going from one node to the next, known as a "walk".

Y = subsets \tilde{Y} of T , such that there exists a walk in the graph containing \tilde{Y} .

t_0 = A node of the graph that is assigned as the start node.

It may not be clear that affine irreducible Coxeter groups have regular languages of reduced words, such as our previous example of \tilde{A}_2 . However, By Gabor Moussong's thesis in 1988, we have this is just the case. Five years later, Brink and Howlett prove that Coxeter groups are automatic. [6]

For Coxeter groups, due to the deletion and exchange property, we have that for any finite Coxeter group the expression for a word can always be reduced down. Also, a significant theorem from [5], Theorem 4.8.3 gives that the language of reduced expressions is regular. From this, we can separate the automaton into two different camps for Coxeter groups depending on their cardinality. In the first camp, we have finite Coxeter groups which the automaton can be read off by the poset of the right weak Bruhat order of (W, S) . The right weak Bruhat order of (W, S) will produce out a finite state automaton. In the second camp, we have the affine irreducible Coxeter groups which can produce out infinite automaton. Our next goal is to make sure we can produce an finite state automaton that recognizes an affine irreducible Coxeter group.

Warning 3.1.3. An automaton for a Coxeter group is not unique! We refer to [24], Example 6.2 with regards to the infinite dihedral Coxeter group with the presentation:

$$W = \langle s, t \mid s^2 = t^2 = e \rangle$$

we construct a third automaton in which W can be recognized.

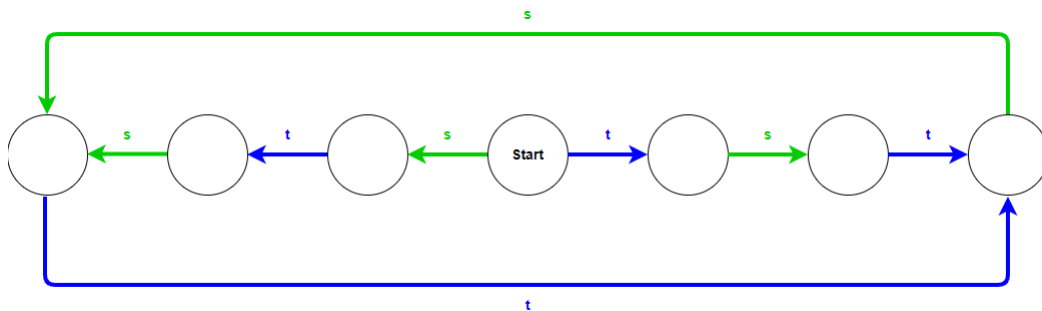

Figure 3.1. \tilde{A}_1 Automaton

We now see that an affine irreducible Coxeter group can take on many variations of a f.s.a.. The following definition will help us narrow down what we are looking at.

Definition 3.1.4. Let W be a Coxeter group and A an automaton for W with corresponding state set T_A . Then A is *minimal* if whenever B is also an automaton for W with corresponding state set T_B , we have $|T_A| \leq |T_B|$.

Example 3.1.5. $|T_B| = 7$ in the previous example, while $|T_A| = 3$ with the removing the two outer nodes on the left and the right.

There are conditions in which a certain automaton structure for a Coxeter group, the Brink-Howlett automaton, is considered minimal or not.

Theorem 3.1.6. [14] *The Brink-Howlett automaton A_{BH} is minimal if and only if $E = \Phi_{sph}^+$, where Φ_{sph}^+ is the set of roots supported on a standard spherical subsystem, i.e. the corresponding root system is finite.*

1. when W is finite,
2. when W is right-angled, i.e. $m_{s,t} = 2$ or ∞ for all $s \neq t$.
3. when the Coxeter graph Γ is a complete graph,
4. when W is of type \tilde{A}_n ,
5. when W has rank 3.

Parkinson and Yau give conditions in which a Coxeter group's Brink-Howlett automaton can be minimal.

Theorem 3.1.7. [19] *Let (W, S) be a finitely generated Coxeter system. The following are equivalent:*

1. The Brink-Howlett automaton A_{BH} is minimal.
2. The Coxeter graph of (W, S) does not have a subgraph contained in X . See citation for X .
3. The set of elementary roots is $E = \Phi_{sph}^+$.

Parkinson and Yau also give conditions in which the Brink-Howlett automaton is not minimal. [19]

Theorem 3.1.8. [19] Let (W, S) be a finitely generated Coxeter system. If there exists $J \subset S$ and $t \in S$ such that:

1. J is spherical, and
2. $J \cup \{t\}$ is not spherical, and
3. $w_J(\alpha_t) \in E$,

then the automaton A_{BH} is not minimal.

We now take a faithful attempt in order to investigate how to build an automaton for a Coxeter group. We know that that a word $w \in W$ can be represented by a string of generators $w = s_1 s_2 \dots s_k$. Beginning at the start node, which is the empty word, we read the word from left to right in which one generator is applied at a time by following a directed edge through the transition function μ . If there is a path for the complete word of w then the word is accepted, otherwise, this word is rejected. We discard the rejected states. Thus, taking $T = W$ and acceptance as w to ws if $l(ws) > l(w)$. Suppose that W is an infinite Coxeter group. Then, \bar{A} should have an infinite amount of nodes. However, this is a contradiction as seen in the previous warning. Therefore, a one-to-one correspondence with nodes to elements will not work if we wish to construct a f.s.a..

Let us consider another approach. Recall the *descent set* of w ,

$$D(w) = \{\alpha \in \Phi^+ \mid w(\alpha) \in \Phi^-\}.$$

Let $T = D(w)$. We define the transition function $\mu : T \times S \rightarrow T$ as follows:

$$\mu(D(w), s) = \begin{cases} \text{Rejected,} & \text{if } \alpha_s \in D(w) \\ D(ws), & \text{if } \alpha_s \notin D(w). \end{cases}$$

We then create an edge labelled with the weight s whenever $\alpha_s \notin D(w)$. It may come as a surprise that there exists a relation between $l(w)$ and $D(w)$.

Proposition 3.1.9. ([24], Proposition 3.10) $|D(w)| = l(w)$.

Proof. Suppose that $l(w) = 1$. This holds since s is the only generator with respect to α_s that makes $s(\alpha_s) = -\alpha_s$ and permutes the rest of the positive roots with respect to s . We now proceed

by induction on $l(w)$. Suppose that the result holds for an arbitrary $v \in W$. Take $w = vs$, with $s \in S$ with $l(vs) > l(v)$. Since $l(vs) > l(v)$, we have $v(\alpha_s) > 0$ as shown previously. Thus, $(\alpha_s) \in \Phi^+$ which implies that $\alpha_s \notin \Phi^-$. Therefore, $\alpha_s \notin D(w)$. Let $\beta \in \Phi^+$, by the permutation of roots

$$w(\beta) \in \Phi^- \iff \beta = \alpha_s \text{ or } s(\beta) \in D(v).$$

Since $\alpha_s \notin D(v)$, by the induction hypothesis, we have $|D(w)| = l(v) + 1 = l(w)$. \square

Is there a nice way to extend $D(w)$ to $D(ws)$? The answer is affirmed by the following proposition.

Proposition 3.1.10. ([24] , Proposition 6.5) *Let $w \in W$ be such that $l(w) = k$. Suppose that $D(w) = \{\beta_1, \beta_2, \dots, \beta_k\}$. If $s \in S$ is such that $l(ws) > l(w)$, then $D(ws) = \{\alpha_s\} \cup \{s(\beta_1), s(\beta_2), \dots, s(\beta_k)\}$.*

Proof. Let $s \in S$ be such that $l(ws) > l(w)$. Since $w(\beta_i) < 0$ for all $\beta_i \in D(w)$, then $ws(s(\beta_i)) = wss(\beta_i) = w(\beta_i) < 0$. Since $s(\alpha_s) = -\alpha_s < 0$, we have that $ws(\alpha_s) = -w(\alpha_s)$, which gives $w(\alpha_s) > 0$. If $w(\alpha_s) < 0$ then we would obtain $l(ws) < l(w)$ which is a contradiction. Since $l(w) = |D(w)|$ we have that $D(ws)$ is exactly $\{\alpha_s\} \cup \{s(D(w))\}$. \square

Now we have a method to make walks in the automaton where the nodes correspond to $D(w)$, and not w . However, if a Coxeter group is infinite, then there could be infinitely many roots in $D(w)$.

We now try a third approach to constructing the automaton. We take $T := D(w) \cap \Sigma$. This set only considers the small roots which become negative when acted upon by w and rejects all of the non-small roots. T is also finite since $|\Sigma| < \infty$. This will give us a finite amount of nodes. For our transition function μ , we replace $D(w)$ with $D(w) \cap \Sigma$ and $D(ws)$ with $D(ws) \cap \Sigma$. We can rigorously define the sets we shall use to construct the Brink-Howlett automaton.

Definition 3.1.11. The **small descent set** of $w \in W$ is

$$D_\Sigma(w) = \{\alpha \in \Sigma | w(\alpha) < 0\}.$$

Can we extend this definition to $D_\Sigma(ws)$ from $D_\Sigma(w)$? We show that this is possible through a lemma. We first introduce a proposition to help us prove our lemma.

Proposition 3.1.12. ([5], Proposition 4.5.4) Let $\alpha, \beta \in \Phi^+$

1. If $|\langle \alpha, \beta \rangle| < 1$ then the subgroup generated by s_α , and s_β is a finite dihedral group.
2. If $\langle \alpha, \beta \rangle \leq -1$ then the subgroup generated by s_α and s_β is an infinite dihedral group. Furthermore, the roots $(s_\alpha s_\beta)^n(\alpha)$, for $n = 0, 1, 2, \dots$ are all positive linear combinations of α and β .

Proof. See citation. □

Lemma 3.1.13. ([24], Lemma 6.7) If $\alpha \in \Sigma$, $s \in S$ and $w \in W$ is such that $s(\alpha) \in \Phi^+ \setminus \Sigma$ and $l(ws) > l(w)$. Then, $ws(\alpha) > 0$.

Proof. Since $l(ws) > l(w)$ we have that $w(\alpha_s) > 0$. We obtain $ws(\alpha_s) = -w(\alpha_s) < 0$. Let $ws(\alpha) < 0$. Since Σ is an order ideal, and for $\alpha \in \Sigma$ where $s(\alpha) \in \Phi^+ \setminus \Sigma$ we obtain $\langle \alpha, \alpha_s \rangle \leq 1$. Due to the previous proposition stated, $ws(\alpha)$ and $ws(\alpha_s)$ both are negative. We achieve for the positive linear combinations of α and α_s with $n \in \mathbb{N}$

$$(ws((s_\alpha s)^n(\alpha))) = ws(\lambda\alpha + \mu\alpha_s) = \lambda ws(\alpha) + \mu ws(\alpha_s) < 0, \quad \lambda, \mu \in \mathbb{R}.$$

This implies $|D(ws)| = \infty$ which is a contradiction since $l(ws) = |D(ws)|$.

Thus, $ws(\alpha) > 0$. □

Proposition 3.1.14. ([24], Proposition 6.8) $w \in W$, $s \notin D_\Sigma(w)$. Then,

$$D_\Sigma(ws) = \{\alpha_s\} \cup \{s(\beta) : \beta \in D_\Sigma(w) \cap \Sigma\}$$

Proof. Suppose $\alpha \in D_\Sigma(ws)$ which implies $\alpha \in \Sigma$ and $ws(\alpha) < 0$. By the previous lemma we have $s(\alpha) \notin \Phi^+ \setminus \Sigma$. We first consider the case that $s(\alpha) \in \Phi^-$ which implies $\alpha = \alpha_s$. In the second case, we consider if $s(\alpha) \in \Sigma$. If $w(s(\alpha)) < 0$ we have $s(\alpha) \in D_\Sigma(w)$. By containment, we achieve $D_\Sigma(ws) \subseteq \{\alpha_s\} \cup \{s(\beta) : \beta \in D_\Sigma(w) \cap \Sigma\}$.

For the other inclusion, let $\alpha \in \{\alpha_s\} \cup \{s(\beta) : \beta \in D_\Sigma(w) \cap \Sigma\}$. We have two cases again. For the first case, $\alpha = \alpha_s$. If $\alpha = \alpha_s$ then $w(s(\alpha)) = w(-\alpha_s) = -w(\alpha_s) < 0$. For the second case, $\alpha = s(\beta)$ which gives $ws(\alpha) = ws(s(\beta)) = w(\beta) < 0$.

□

3.1.1. Brink-Howlett Automaton and Examples

We now give the algorithm in which to construct the Brink-Howlett automaton. This automaton will let us calculate reduced words of length n for our affine irreducible Coxeter systems.

Proposition 3.1.15. ([24], Proposition 6.9) (*Brink-Howlett automaton*) *Let (W, S) be a Coxeter System. Construct a finite state automaton as follows:*

1. *First, find the small roots Σ of W using the definition of Σ .*

Let $T = \{D_\Sigma(w) \mid w \in W\}$. We construct A_{BH} iteratively.

2. *Initialize the algorithm by setting $D_\Sigma(e) = D \in T$.*

3. *For each $s \in S$ such that $\alpha_s \notin D$, put an s -labeled directed edge:*

$$D \xrightarrow{s} \{\alpha_s\} \cup \{s(D) \cap \Sigma\}$$

by the previous proposition, $\{\alpha_s\} \cup \{s(D) \cap \Sigma\} \in T$ when $\alpha_s \notin D$.

4. *Repeat step 3 for each $D \in A_{BH}$.*

One can see the Brink-Howlett automaton explicitly calculated out for \tilde{A}_2 in [24]. There has also been work on what can we say for the Brink-Howlett automaton with regards to minimality. [19] We go canonically by looking at $\tilde{A}_1 = \langle a, b \mid a^2 = b^2 = e \rangle$.

Example 3.1.16. Take $(W, S) = (\tilde{A}_1, \{a, b\})$ which has the reduced words

$$\{\emptyset, a, b, ab, ba, aba, bab, \dots, ababa\dots, babab\dots\}$$

We now construct the Brink-Howlett automaton for \tilde{A}_1 . First, we start by finding all the small roots Σ . Observe that $m(a, b) = \infty$ which implies that $\langle \alpha_a, \alpha_b \rangle = -1$. Since $\alpha_a, \alpha_b \in \Delta$, then $a(\alpha_b) = \alpha_b + 2\alpha_a \notin \Sigma$ and $b(\alpha_a) = \alpha_a + 2\alpha_b \notin \Sigma$. Therefore, $\Sigma = \{\alpha_a, \alpha_b\}$. Now we determine the small descent sets.

The nodes of the automaton are given by the small descent sets

$$D_\Sigma(w) = \{\alpha \in \Sigma \mid w(\alpha) < 0\}$$

We begin with the identity. The start node is given by $D_\Sigma(e) = \{\emptyset\}$. Next, we look at

$$D_\Sigma(a) = \{\alpha_a\} \cup \{a(D_\Sigma(e)) \cap \Sigma\} = \{\alpha_a\}$$

$$D_\Sigma(b) = \{\alpha_b\} \cup \{b(D_\Sigma(e)) \cap \Sigma\} = \{\alpha_b\}$$

Now using $D_\Sigma(b)$ and $D_\Sigma(a)$ we calculate out the new descent sets. However,

$$D_\Sigma(ab) = \{\alpha_b\} \cup \{b(D_\Sigma(a)) \cap \Sigma\} = \{\alpha_b\} = D_\Sigma(b)$$

$$D_\Sigma(ba) = \{\alpha_a\} \cup \{a(D_\Sigma(b)) \cap \Sigma\} = \{\alpha_a\} = D_\Sigma(a)$$

Hence our algorithm has stopped because we have no new descent sets made from our previous iteration. Since no new nodes were created in this algorithm, we now obtain the following automaton.

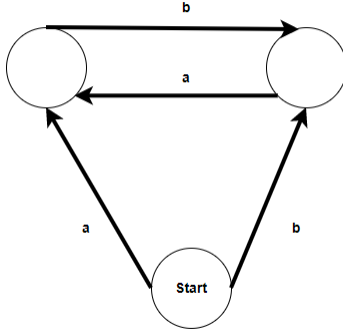

Figure 3.2. \tilde{A}_1 Brink-Howlett Automaton

We obtain the polynomials of reduced words of length n by just following the automaton.

$$R_{(W,S)}(q) = 1 + 2q + 2q^2 + 2q^3 + \dots$$

It may not be so easy to obtain a polynomial just by following the automaton. We now look at another example.

Example 3.1.17. $U(\tilde{A}_2) = \langle a, b, c \mid a^2 = b^2 = c^2 = e \rangle$. It seems that the diagram complexity heightens even just by raising up by one, as shown in the automaton. We give the automaton as shown below skipping calculation since it follows in line with the previous example.

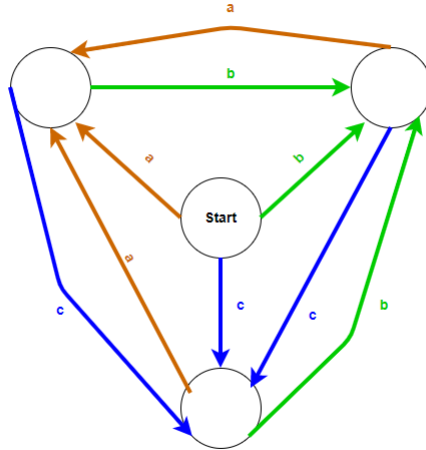

Figure 3.3. $U(\tilde{A}_2)$ Brink-Howlett Automaton

Now that we have the automaton for a given Coxeter system that produces out a finite state automaton, it would be nice if we could encode the automaton as a polynomial.

The adjacency matrix of $A_{BH}(U(\tilde{A}_2))$ is given by

$$A = \begin{bmatrix} 0 & 1 & 1 & 1 \\ 0 & 0 & 1 & 1 \\ 0 & 1 & 0 & 1 \\ 0 & 1 & 1 & 0 \end{bmatrix}$$

where the entry $a_{u,v}$ is representative of the number of edges between $u \mapsto v$ in the automaton. We now introduce from the subject area of Statistical Mechanics the *transfer matrix method*. Let $P_{u,v}(n)$ denote the paths from u to v with n edges. Let $[u, v]$ be the interval that starts at u and

ends at v . Take

$$\begin{aligned}
P_{u,v}(n) &= \sum_{w \in [u,v]} a_{u,w} P_{w,v}(n-1) \\
&= A * P(n-1) \\
&= A^n * P(0) \\
&= A^n * I \\
&= A^n.
\end{aligned}$$

With the following matrix obtained, we would like a way to calculate a generating function for $P_{u,v}(n)$. We have the following generating function which will let us see how many reduced words of length n there are.

Theorem 3.1.18. (*[5], Fact A4.1.2*) For a fixed $u, v \in [n]$,

$$\sum_{n=0}^{\infty} P_{uv}(n)x^n = \frac{(-1)^{u+v} \det(I - xA; v, u)}{\det(I - xA)}$$

where semicolon tells to delete the v -th row and u -th column, and I is the $n \times n$ identity matrix .

We now conclude our example through calculating out $A_{BH}(U(\tilde{A}_2))$.

$$\sum_{n=0}^{\infty} P_{1,3}(n)x^n = \frac{x(1+x)^2}{(1+x)^2(1-2x)} = \frac{x}{1-2x}$$

r_n = reduced words of length $n = P_{1,2}(n) + P_{1,3}(n) + P_{1,4}(n) = 3P_{1,3}(n)$ by symmetry of our automaton.

If $n = 0$, then $r_0 = 1$. Compiling what we have, we obtain

$$\sum_{n=0}^{\infty} r_n x^n = 1 + \frac{3x}{1-2x} = 1 + 3 \sum_{n=1}^{\infty} (2)^{n-1} x^n.$$

By the geometric series we have our answer for the number of reduced words of length n .

In both examples we have the coefficients have turned out to be at least integers. The following theorem gives comfort to our reader about the coefficients of our formal power series.

Theorem 3.1.19. ([4] [5], Fact A4.1.3 and Theorem 4.9.1) *The formal power series of the relation of words of a given Coxeter System (W, S) is rational polynomial. We denote this polynomial as*

$$R_{(W,S)}(q) = \sum_{k \geq 0} r_k q^k$$

where r_k equals the number of directed paths of length k in the automaton from the start node to any node in $A_{BH}(W)$.

Proof. Using transfer matrix method since $|S| < \infty$ in coordination with [4] gives us our result. \square

We do not know much about the enumeration of reduced words, but for finite Coxeter groups there has been significant progress with the implementation of Standard Young Tableaux. ([5], Section 7.4) However, for affine irreducible Coxeter groups, there seems to be no closed algebraic form for writing the coefficients of the rational polynomial that a Coxeter system gives, but there has been algorithmic work by Avajö with triangular groups of rank 3. [2]

Creating the graph of \tilde{A}_2 , even though the process is finite, it may take a considerable amount of time to construct and there should be a way in order to count the number of states of the graph given by a Coxeter group. Found in Henrik Eriksson's Ph.D thesis, we have from Kimmo Eriksson's Ph.D thesis the number of states for an affine Coxeter group. Notably given by $(1+h)^{|\Phi|}$ where h is the Coxeter number and $|\Phi|$ is the rank of the roots. [11] [12]

One also sees from Eriksson's paper that the canonical automaton is not necessarily minimal with \tilde{C}_n . Work has been done in terms of Shi-arrangements in order to get a bound for an arbitrary Coxeter group considering its number of states. [20]

Group	$ \Sigma $	Number of states
\tilde{A}_n	$n(n+1)$	$(n+2)^n$
\tilde{B}_n	$2n^2$	$(2n+1)^n$
\tilde{C}_n	$2n^2$	$(2n+1)^n$
\tilde{D}_n	$2n(n-1)$	$(2n-1)^n$
\tilde{E}_6	72	13^6
\tilde{E}_7	126	19^7
\tilde{E}_8	240	31^8
\tilde{F}_4	48	13^4
\tilde{G}_2	12	7^2

Table 3.1. Number of States for Affine Irreducible Coxeter Groups

3.2. Conclusion

We have seen through the construction of the Brink-Howlett automaton how to count the reduced words of length n subject to minimality conditions. Due to the number of states of the automaton being given by $(1 + h)^{|\Phi|}$ where h is the Coxeter number of our group.

Finding applications for the Brink-Howlett automaton has proved to be fruitful for Automata Theory. However, finding more Combinatorial applications has been difficult throughout the years. We encourage future research by computer generated chromatic polynomials for the rest of the affine irreducible Coxeter groups via their Brink-Howlett automaton. This provides the global view of proper colorability of Coxeter groups rather than a locally tessellated argument used in previous argumentation of proper colorability. Using the Tutte Polynomial will give an automatic way to compute chromatic polynomials via our automaton for our affine irreducible Coxeter groups. We warn the reader that enumerative properties of the chromatic polynomial will not hold. For example, the number of regions of our hyperplane arrangement will not hold for the Brink-Howlett automaton for \tilde{A}_1 when plugging in -1 into our chromatic polynomial will not result in the correct answer.

We also encourage further research into showing that the automation may constitute a cluster algebra that is of infinite type. Cluster Algebras are well known for ADE Dynkin diagrams and taking the tensor product of two ADE Dynkin Diagrams has proven to be fruitful as well. Extending to the automaton of the affine irreducible Coxeter groups may give new sequences not previously seen or has new combinatorial connections.

REFERENCES

- [1] F. Ardila, *Coxeter Groups*, (Fredrico, 2008), San Francisco State University. available at <http://fardila.com/Clase/Coxeter/lectures.html>.
- [2] A. Avasjö, *Automata and growth functions of Coxeter groups*, Lic. Thesis, KTH, Stockholm, Sweden, 2004.
- [3] P. Bahls, *Isomorphism Problem in Coxeter groups*, Imperial College Press, London, (2005).
- [4] J. Berstel and C. Reutenauer, *Rational series and their languages*, EATC Monographs on Theor. Comput. Sci., Springer-Verlag, 1988.
- [5] A. Bjorner, and F. Brenti, *Combinatorics of Coxeter Groups*, Springer, USA, 2005. ISBN-10:3-540-44238-3.
- [6] B. Brink, and R.B. Howlett, *A finiteness property and an automatic structure for Coxeter groups*, *Math. Ann.* **296** (1)(1993), 179-190
- [7] B. Brink, *On Root Systems and Automacy of Coxeter Groups*, Ph.D thesis, University of Sydney (1994).
- [8] N. Bourbaki, *Group et algebras de Lie, Chapt. IV-VI*, Hermann, Paris, (1981).
- [9] W.A. Casselman, *Automata to perform Basic Calculations in Coxeter Groups*
- [10] M. Dehn, *Vber unendliche diskontinuierliche Gruppen*, *Math. Ann.* **71** (1911), 116-144. <https://eudml.org/doc/158521>.
- [11] K. Eriksson, *Strongly convergent games and Coxeter groups*, Thesis, Dept of Math., KTH, Stockholm (1993).
- [12] H. Eriksson, *Computational and combinatorial aspects of Coxeter groups*, Thesis, Dept. of Math., KTH, Stockholm (1994).
- [13] J. Humphreys, *Reflection Groups and Coxeter Groups*, Cambridge University Press **29**, (1990). ISBN-13:978-0-521-43613-7.

- [14] C. Hohlweg, P. Nadeau, and N. Williams, *Automata, Reduced Words and Garside Shadows in Coxeter Groups*, Journal of Algebra 2016. **457** pg. 431-456.
- [15] V. Kac, *Infinite Dimensional Lie Algebras* third ed. Cambridge University Press 1990. ISBN-13: 0-521-37215-1.
- [16] D. Krammer, *The conjugacy problem for Coxeter groups*. Groups Geom. Dyn. **3** (2009), no. 1, 71-171.
- [17] H. Matsumoto, *Ge'ne'rateurs et relations des groupes de Weyl ge'ne'ralise's*, C.R. Acad Sci. Paris 258 (1964), 3419-3422. <http://eudml.org/doc/158521>.
- [18] P. Novikov *On the algorithmic unsolvability of the word problem in group theory*, Proceedings of the Steklov Institute of Mathematics (in Russian), **44**: 1–143, Zbl 0068.01301
- [19] J. Parkinson and Y. Yau, *Coxeter systems for which the Brink-Howlett automaton is minimal* Journal of Algebra, **527**, 1 June 2019, 437-446.
- [20] J.-Y. Shi, *Sign types corresponding to an affine Weyl group*, J London Math. Soc. **35** (1987), 56-74. [124]
- [21] R. Stanley, *Enumerative Combinatorics Volume I*, second ed. Cambridge University Press 2012. ISBN-13: 978-1-107-60262-5.
- [22] Wikipedia contributors. *Coxeter–Dynkin diagram*. Wikipedia, The Free Encyclopedia. Wikipedia, The Free Encyclopedia, 7 Aug. 2022. Web. 28 Sep. 2022.
- [23] J. Tits. *Le problem des mots dans les groupes de Coxeter*. In Symposia Mathematica (INDAM, Rome, 1967/68), volume 1, pages 175–185. Academic Press, London, 1969.
- [24] Y. Yau *Automata for Coxeter Groups* University of Sydney, B.Sc. Thesis. November 2018.