



Anchored Leaf

Veteran Mental Health Rehabilitation Center

Piney Mountain, VA



Statement

In order to better serve the soldiers of yesterdays battle, it is through architectural design that we carefully curate an environment that is conducive to healing in order to win todays current war with mental illness associated with veterans

Purpose

- Backstory
 - Family, friends and myself have served or are currently serving





VA



U.S. Department
of Veterans Affairs



VA Medical Hospitals

Facilities that provide veterans with medical care, therapy and testing



Veterans Suicide Rate

- It has been misinterpreted that there are 22 veteran suicides a day
 - Actual number: 16.8 (17)
- The veteran suicide rates in comparison to non-veteran suicide rates
 - 31.7 (32) for every 100,000 veterans
 - 16.1 (16) for every 100,000 non-veterans



Steps for bettering Veterans Mental Health

- Service Animals
- VA Medical Hospitals



Figure 1

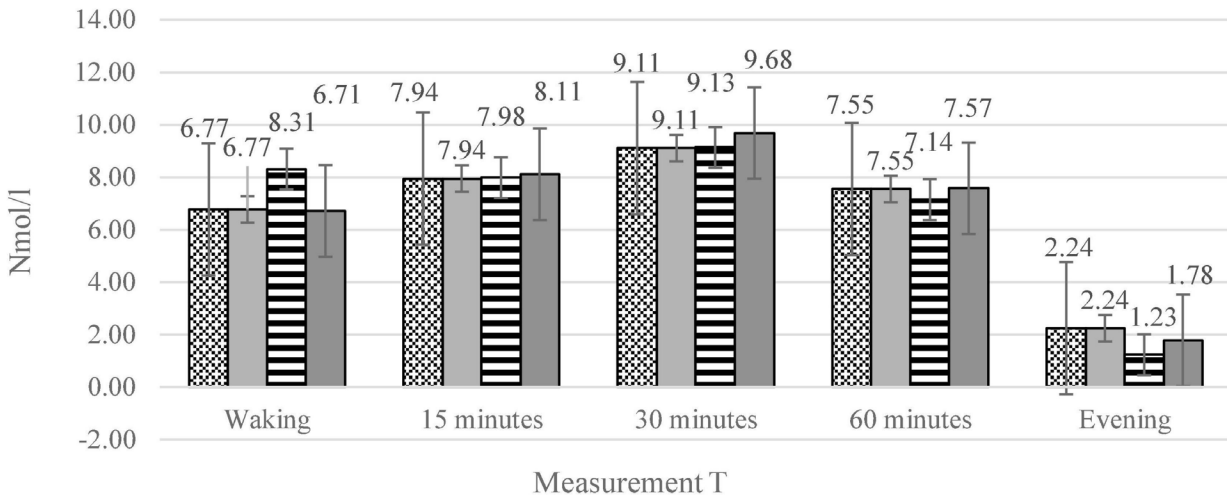

Service Animals

- Service animals are used to those who are in need of them physically and emotionally
- Veterans show less PTSD related symptoms with a service animal
 - The table below have 4 groups:
 - Individuals with PTSD and a service dog:
 - Individuals with PTSD and a companion dog:
 - Individuals with PTSD and no service animal:
 - Individuals with no PTSD
 - Figure 1 shows the salivary cortisol levels, indicator of stress
 - Figure 2 shows the activity levels

Figure 2

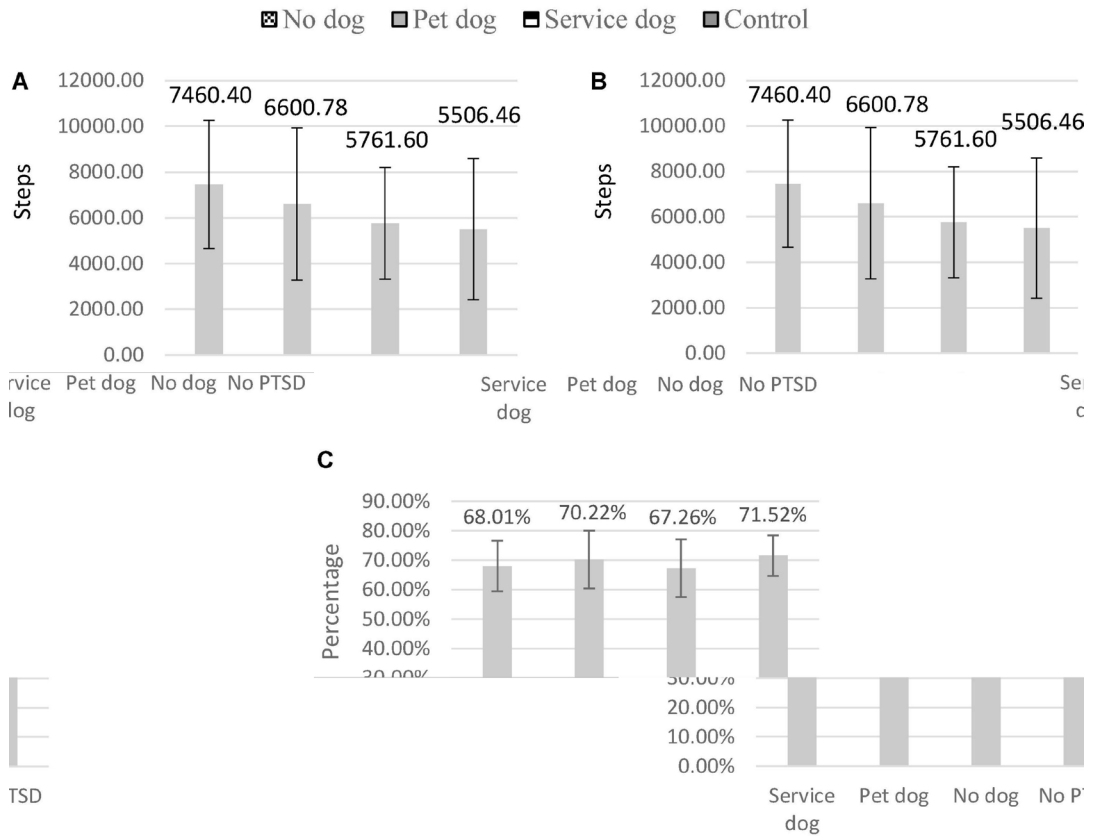

TSD



Case Studies

- Cardinal Recovery
- All Point North
- Usonian Design
- West Maui Hospital



Cardinal Recovery

- The main takeaway from this Cardinal Recovery was the understanding of what addiction was as well as mental health. Addiction is defined as a chronic, relapsing disorder characterized by compulsive drug seeking despite the harmful consequences and long-lasting changes in the brain.

CARDINAL RECOVERY

Causes of Addiction

Signs of Addiction

Treatment

- No answer

Cardinal Recovery

- The main takeaway from this Cardinal Recovery was the understanding of what addiction was as well as mental health. Addiction is defined as a chronic, relapsing disorder characterized by compulsive drug seeking despite the harmful consequences and long-lasting changes in the brain.

CARDINAL RECOVERY

Causes of Addiction

- No answer

Signs of Addiction

- Weight Change
- Poor Sleep Patterns
- Hallucinations
- Financial Issues
- Relationship Issues

Treatment

Cardinal Recovery

- The main takeaway from this Cardinal Recovery was the understanding of what addiction was as well as mental health. Addiction is defined as a chronic, relapsing disorder characterized by compulsive drug seeking despite the harmful consequences and long-lasting changes in the brain.

Causes of Addiction

- No answer

Signs of Addiction

- Weight Change
- Poor Sleep Patterns
- Hallucinations
- Financial Issues
- Relationship Issues

Treatment

- Outpatient Programs
- Residential
- Detox
- Medication

CARDINAL
RECOVERY



All Points North

- Located in Denver CO
 - Provides Outpatient and Residential Programs for patients



Usonian Design

- Usonian design was made popular by Frank Lloyd Wright
- Characteristics
 - 1 story building
 - Small
 - Natural lighting
 - Natural Heating and Cooling
 - Flat Roofs
 - Natural Ornamentation

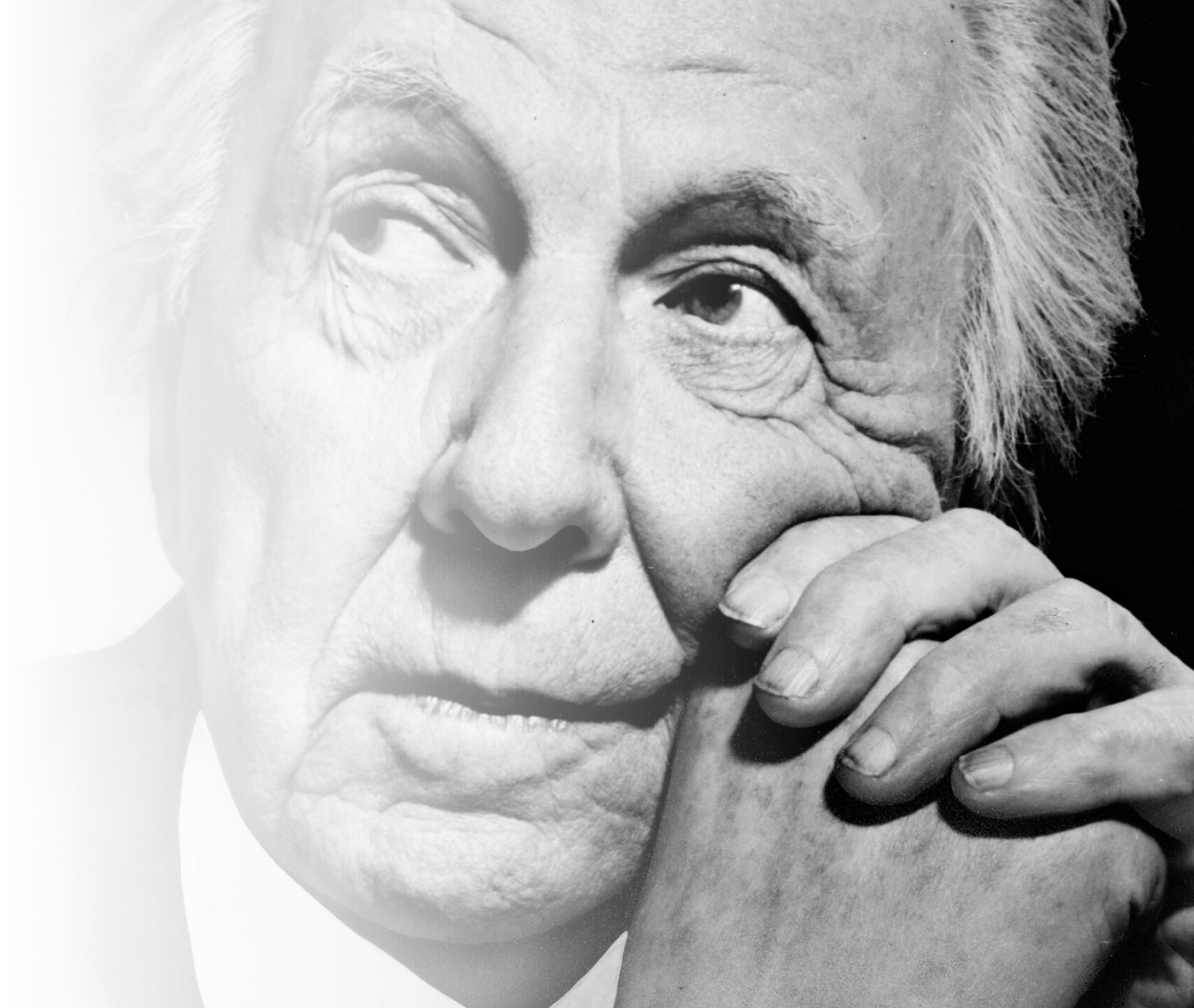



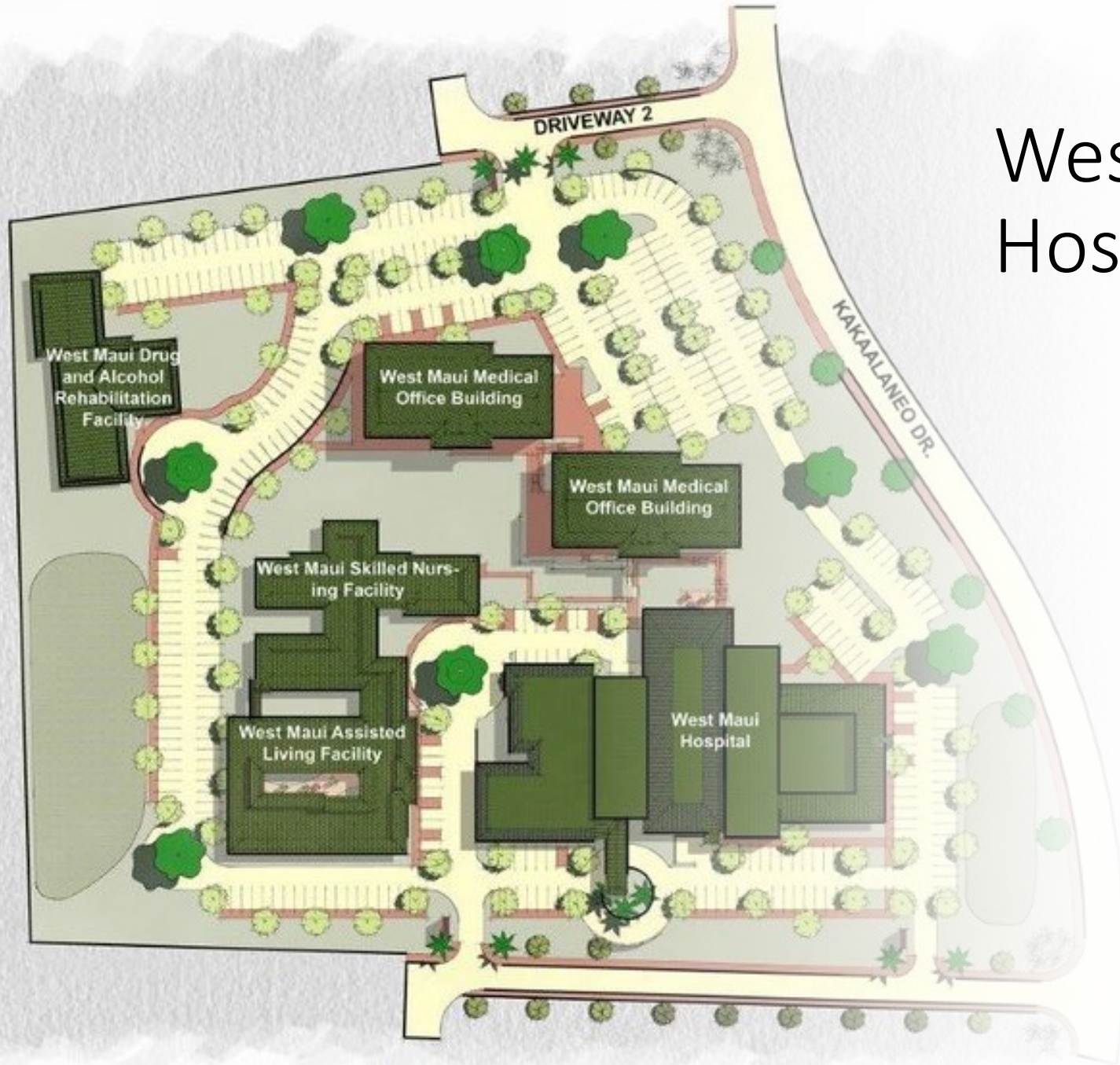

West Maui Hospital



Site

- Located in Piney Mountain, VA
 - 2hr drive to Washington DC and Arlington Cemetery
 - North of Charlottesville
- Why Virginia?
 - Virginia has one of the most veteran populace
 - <780,000
 - Gulf War Veterans being the most prominent
 - VA Medical Centers
 - Richmond
 - Hampton
 - Salem



Piney
Mountain

VA



• Richmond

• Salem

• Washington D.C

• Hampton



VA Medical
Centers Virginia

- Hampton
- Salem
- Richmond



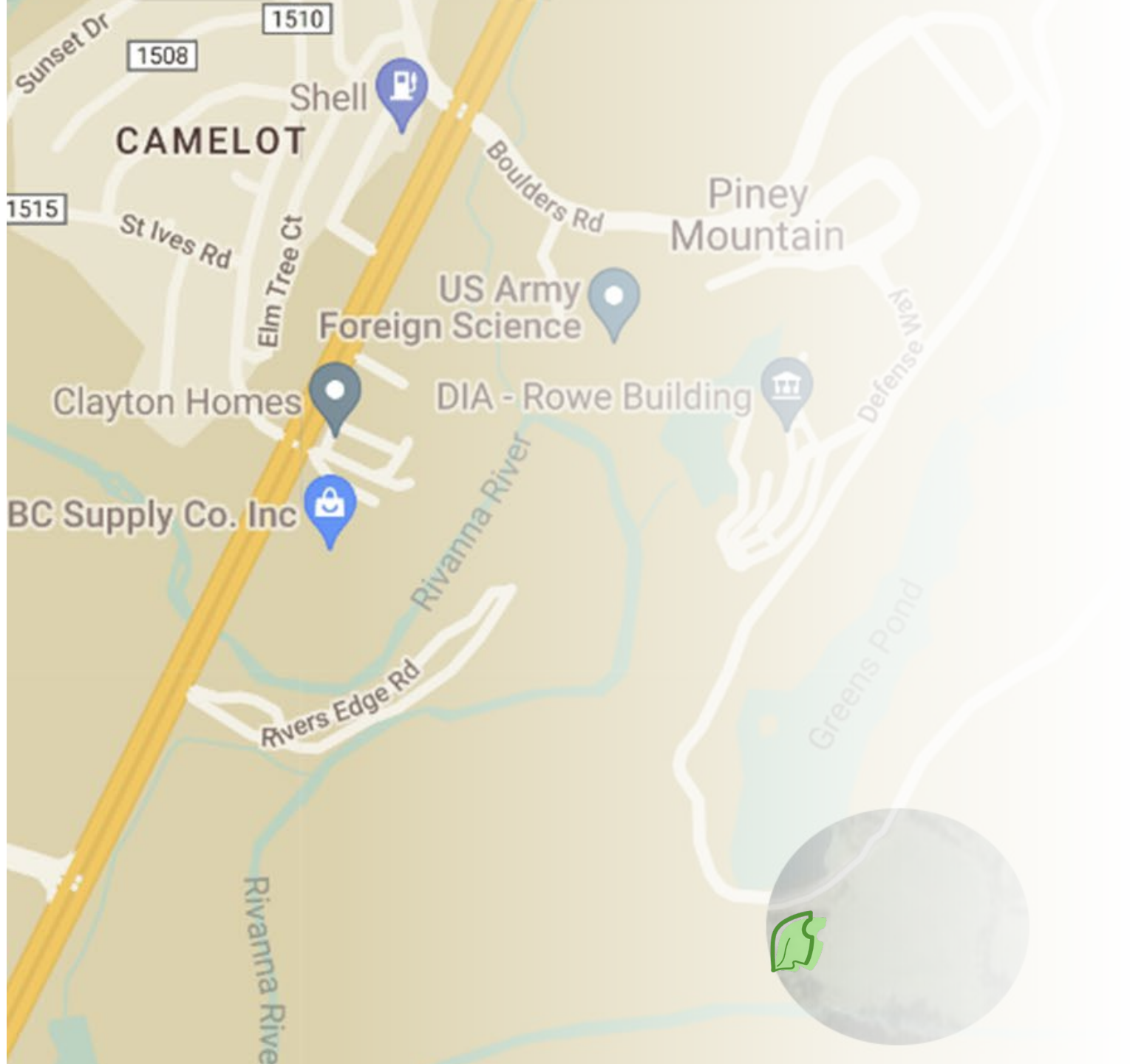

Site





Master Plan

- Living Center
- Community Center
- Medical Center

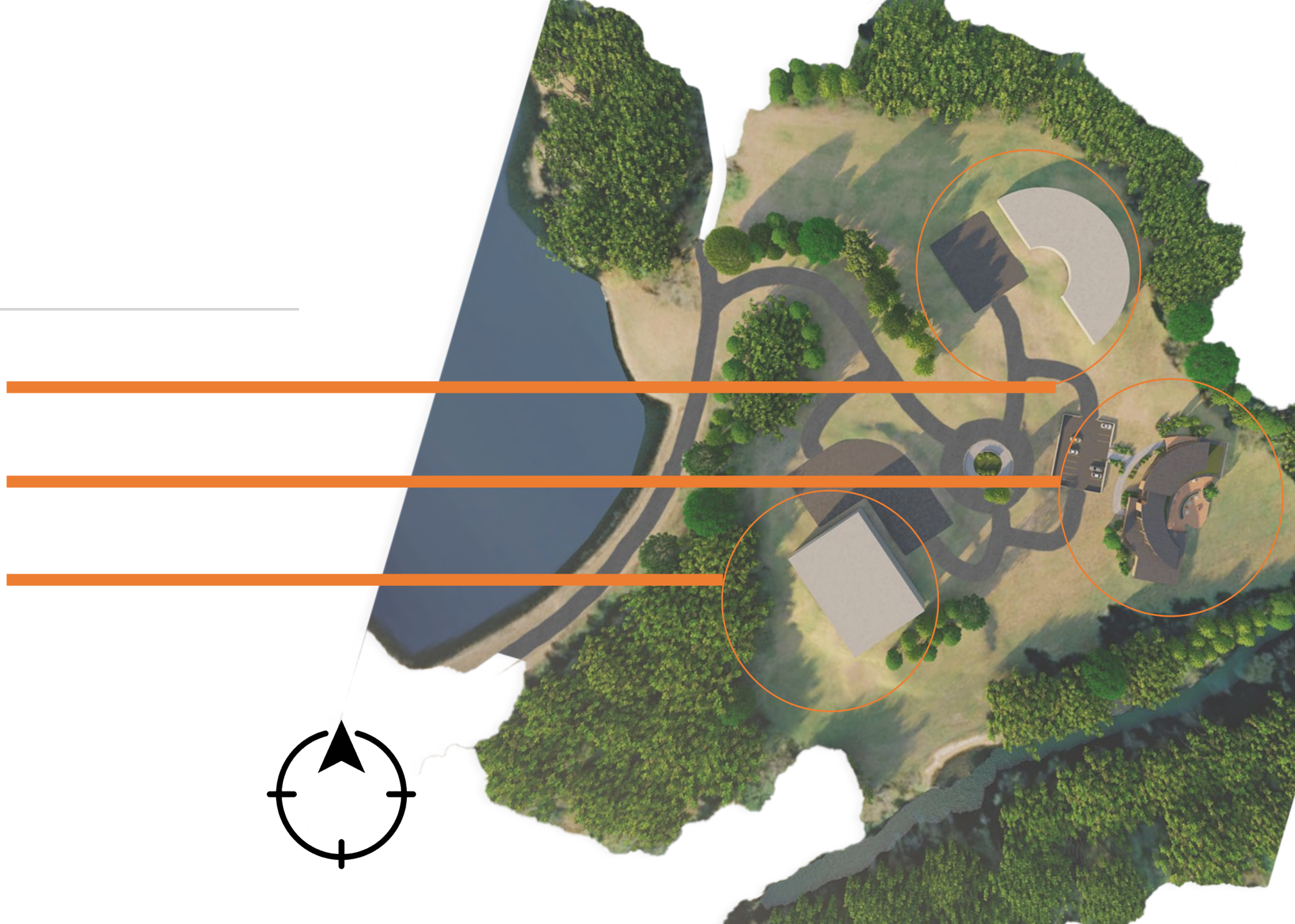



Community



Design

- The overall goal when approaching this design was to make it not feel like another institution
 - Hearthly
 - Residential



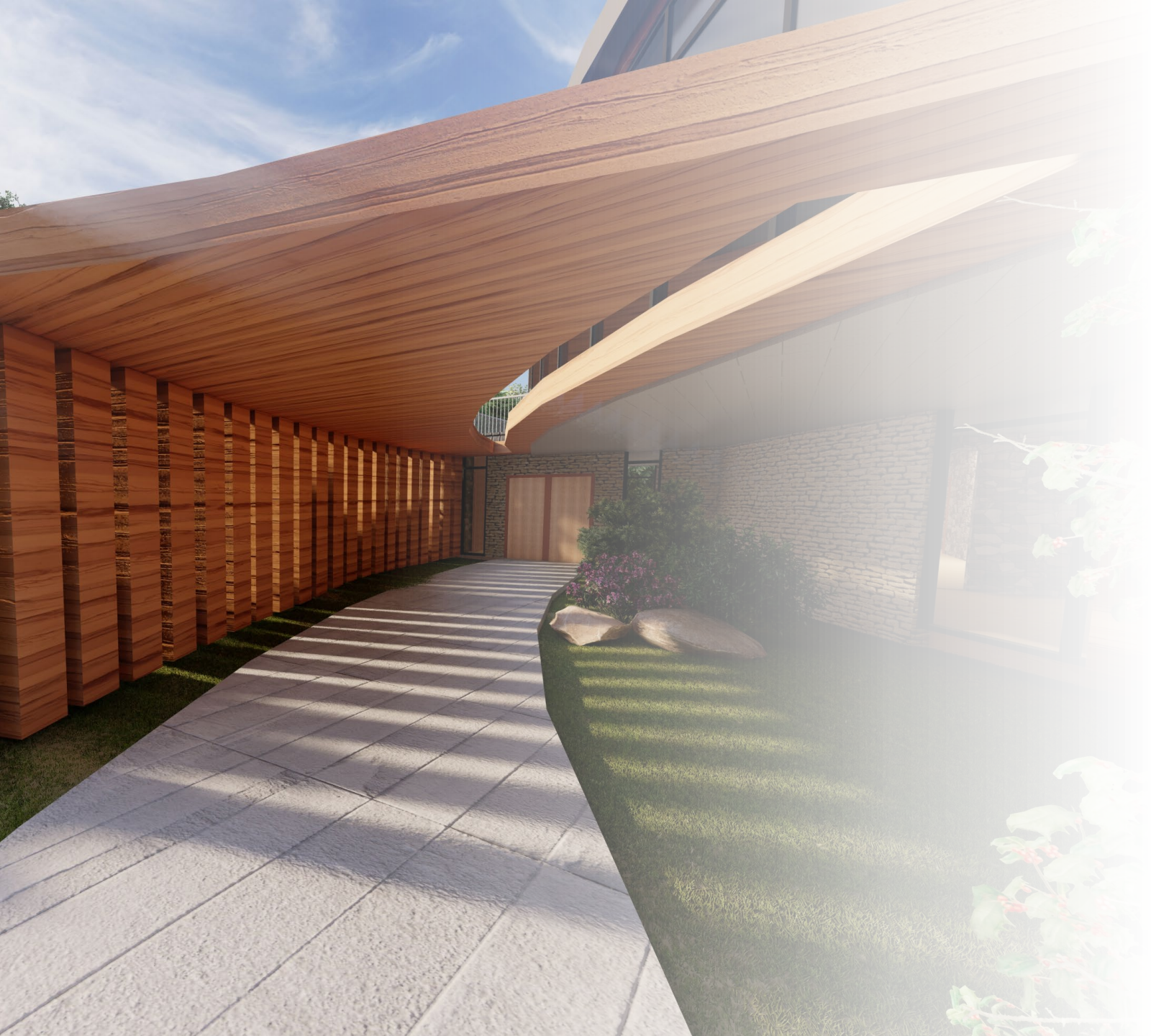

Why?

- In the eyes of veterans, as well as civilians, most mental health centers have more of a hospital like feel. Speaking for veterans, the goal is to not have them feel like they are at such a center and that Anchored Leaf is designed to help relieve that sense of stress, anxiousness, as well as hierarchy.



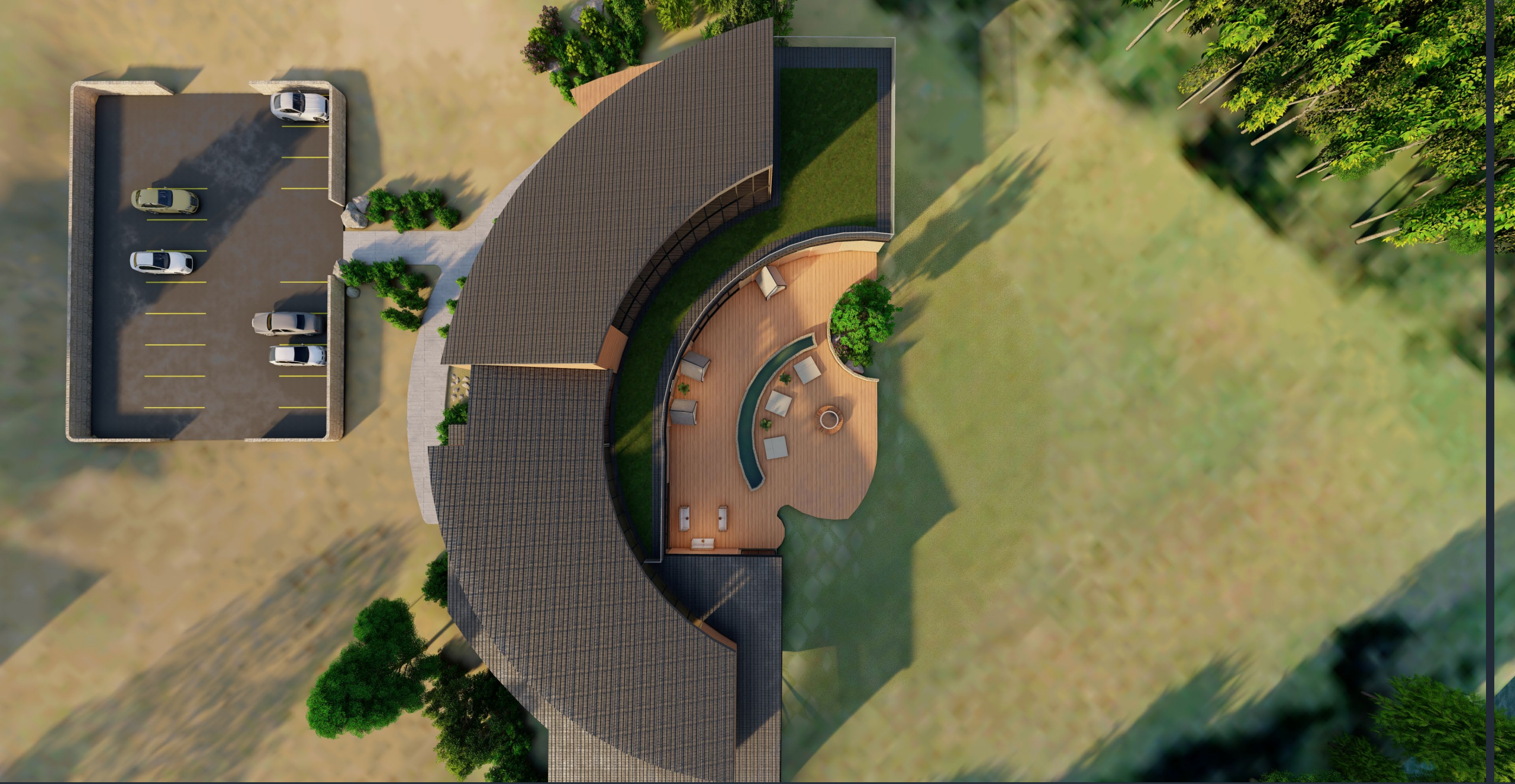





Level 1

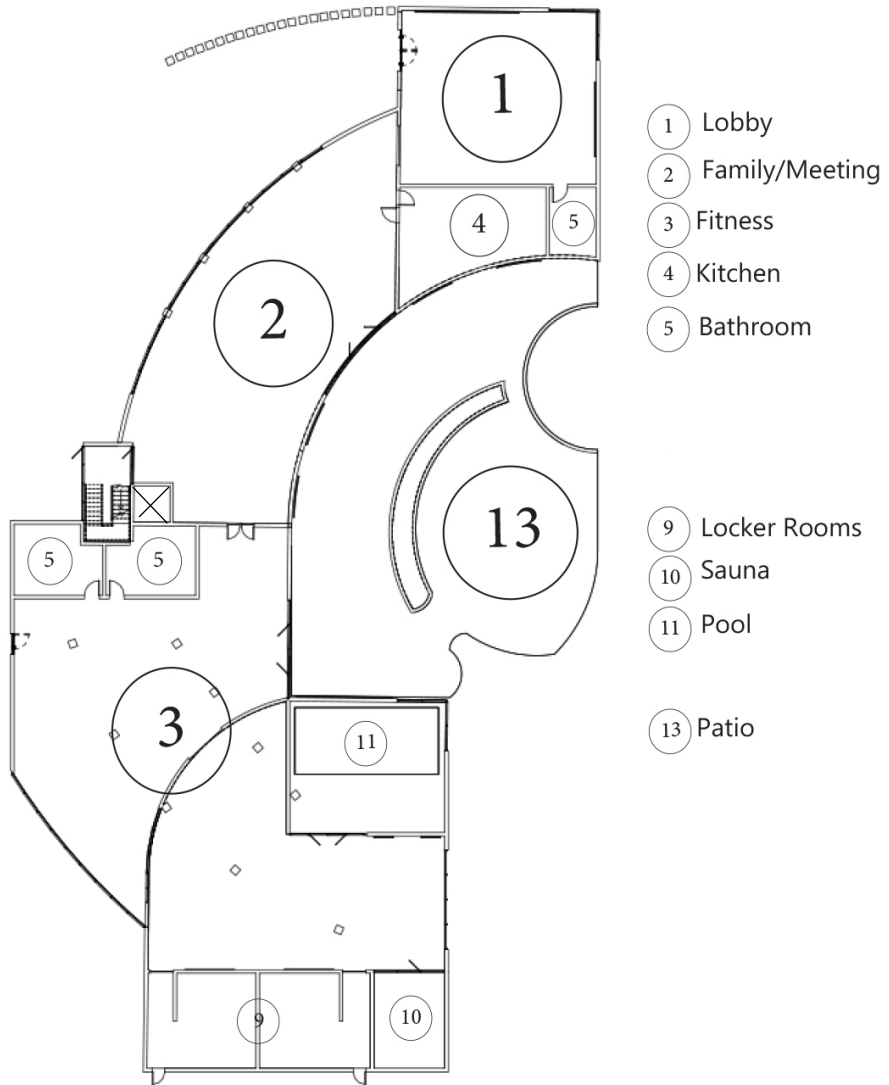













Level 2

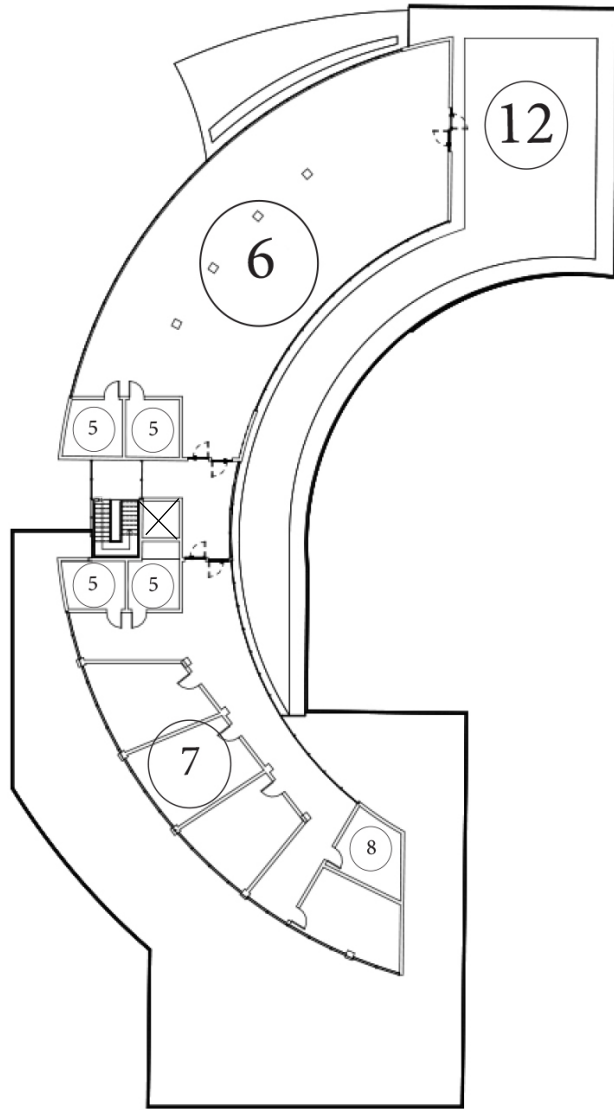

- 5 Bathroom
- 6 Creative Studio
- 7 Therapy
- 8 Storage
- 12 Garden Roof







“Peace has victories, but it takes brave men and women to win them”

- Ralph Waldo Emerson



Thank you.

